

PAMPHLET }  
 No. 381-11 }

HEADQUARTERS  
 DEPARTMENT OF THE ARMY  
 WASHINGTON, D.C., 27 May 1966

TABLE OF CONTENTS

	Page
EMERGENCY HANDLING GUIDANCE FOR EXPLOSIVE DEVICES.....	1
<b>GRENADERS:</b>	
Stick Hand Grenade.....	9
Defensive Hand Grenade.....	11
Offensive Hand Grenade.....	13
Milk Can Hand Grenade.....	15
Shaped Charge Hand Grenade.....	17
 <b>MINES:</b>	
Shell Case Mine.....	19
Tin Can Antipersonnel Mine.....	21
Concrete Fragmentation Mine.....	23
Concrete Mound Mine.....	25
Betel Box Mine.....	27
Turtle Mine.....	29
Pineapple Fragmentation Mine.....	31
Dud Shell Mine.....	33
Min Antipersonnel Mine.....	35
Bounding Fragmentation Mine.....	37
DH-10 Directional Mine.....	39
Bevelled Top Water Mine.....	41
Truncated Cone Water Mine.....	43
 <b>DEMOLITIONS:</b>	
Small Truncated Cone-Shaped Charge.....	45
Large Truncated Cone-Shaped Charge.....	47
Turtle Charge.....	49
Cylindrical Charge.....	51
Pole Charge.....	53
Oil Drum Charge.....	55
Bangalore Torpedo.....	57
 <b>FUZES AND FIRING DEVICES:</b>	
Chemical Fuze.....	59
Pressure-Electric Firing Device.....	61
Wristwatch Firing Device.....	63
Mousetrap Firing Device.....	65
 <b>MISCELLANEOUS ITEMS:</b>	
Angled Arrow Trap.....	67

Whip.....	69
Bicycle Mine.....	71
Cartridge Trap (Foot Breaker).....	73
Spike Board Pit.....	75
Tilting Lid Spike Pit.....	77
Pivoted Spike Board.....	79
Venus Flytrap (Pit).....	81
Venus Flytrap (Can).....	83
Sideways Closing Trap.....	85
Trap Bridge.....	87
Suspended Spikes.....	89
Spike Log (Mace).....	91
Cal. .22 Fountain Pen.....	93
Explosive Fountain Pen.....	95
Sodium Incendiary Device.....	97

## EMERGENCY HANDLING GUIDANCE FOR EXPLOSIVE DEVICES

(Extracted from FM 5-31, September 1965)

### 1. GENERAL

Through knowledge of the mechanical details and techniques in the use of standard U.S. mines, grenades, and boobytrapping equipment, a soldier is ordinarily prepared to some extent for dealing with similar equipment of the enemy. However, familiarity with conventional warfare explosive devices is of little or no use in guerrilla warfare. Most enemy boobytraps found recently in guerrilla-infested areas were cunningly and ingeniously improvised and laid. Such boobytraps can rarely be neutralized, even by the most experienced specialists.

### 2. TECHNICIANS

a. Although engineer and infantry specialists are responsible for boobytrap detection and removal, men in all military organizations assigned to combat zone missions must be trained to assist them.

b. If possible, trained engineer, infantry, or explosive ordnance disposal (EOD) units will search out and neutralize all boobytraps in front of friendly troops—or prepare safe passage lanes. Simple boobytraps will be disarmed during attack; those more complicated will be marked by warning signs and reported for removal.

c. Tactical units should bypass boobytrapped areas, especially villages and other inhabited places, to be cleared by specialists later. They will neutralize boobytraps only when necessary for continued movement or operation.

### 3. DETECTION

Detection of boobytraps requires the most careful observation. Soldiers must discipline themselves to be constantly on guard against the possibility of accidentally exploding a boobytrap, especially when moving over an area previously held by the enemy. All soldiers, even those not assigned primary responsibility for locating boobytraps, must be alert for any sign of them. They must always look carefully for concealed boobytraps even when performing normal activities.

### 4. OUTDOOR SEARCH TECHNIQUES

As boobytraps are so deadly and so cunningly conceived and hidden, searchers should be suspicious of—

- All movable and apparently valuable and useful property.
- All disturbed ground and litter from explosive containers.

- c. Marks intentionally left behind to attract or divert attention.
- d. Evidence of former camouflage.
- e. Abrupt changes or breaks in the continuity of any object, such as unnatural appearance of fences, paint, vegetation, and dust.
- f. Unnecessary things like nails, wire, or cord that may be part of a boobytrap.
- g. Unusual marks that may be an enemy warning of danger.
- h. All obstructions, for they are ideal spots for boobytraps. Search carefully before lifting a stone, moving a low-hanging limb, or pushing aside a broken-down wheelbarrow.
- i. Queer imprints or marks on a road, which may lead a curious person to danger.
- j. Abandoned vehicles, dugouts, weeds, machinery, bridges, gullies, defiles or abandoned stores. Walk carefully in or around these as pressure-release devices are easily concealed under relatively small objects.
- k. Areas in which boobytraps are not found immediately. Never assume without further investigation that entire areas are clear.
- l. Obvious tripwires. Even though one tripwire is found attached to an object, others may be also attached. Searching must be complete.

## 5. DISARMING METHODS

a. *Neutralization.* Neutralization, the making of a dangerous boobytrap safe to handle, involves two steps: (1) disarming or replacing safeties in the firing assembly, and (2) defuzing or separating the firing assembly from the main charge and the detonator from the firing assembly. If neutralization is not possible, the boobytrap must be destroyed.

b. *Destruction in Place.* A boobytrap may be destroyed in place if some damage is acceptable, as is generally the case out of doors. An operator may initiate a boobytrap by its own mechanism and riggings or by a rope from a safe distance (at least 50 meters away).

c. *Removal of the Main Charge.* Before attempting removal, careful probing around the main charge is necessary to locate and neutralize all antilift devices. To avoid casualty, the type of firing mechanism must be recognized and all safety devices must be replaced. If complete neutralization seems doubtful, the charge should be pulled from place by a grapnel or rope from a safe location (at least 50 meters away). After pulling the charge, the operator should wait at least 30 seconds as a safeguard against a concealed delay action fuze.

d. *Hand Disarming.* None but trained specialists should attempt hand disarming—unless the boobytrap's characteristics and disarming techniques are well known. Trained specialists *only* should inspect and destroy all unusual or complicated mechanisms. The following procedures for hand neutralization should be used for guidance only, as the exact sequence depends on the type of device and manner of placement.

- (1) Do not touch any part of a boobytrap without first examining it thoroughly. Locate all firing devices and their triggering mechanisms.
- (2) When tracing wires, look for concealed intermediate devices laid to impede searching. Do not disturb any wires while examining the boobytrap.
- (3) Cut loose tripwires only after careful examination of all connecting objects and after replacing all safeties.
- (4) Trace taut wires and disarm all connected firing devices by replacing safeties. Taut wires should be cut only after eliminating the danger at both ends.
- (5) Replace safeties in all mechanisms, using nails, lengths of wire, cotter pins, and other similar objects.
- (6) Never use force in disarming firing devices.
- (7) Without disturbing the main charge, cut the detonating cord or other leads between the disarmed firing device and the main charge.
- (8) Cut wires leading to an electrical detonator—one at a time.

- (9) When using a probe, push it gently into the ground. Stop pushing when you touch any object (it may be a pressure cap or plate).
- (10) Once separated, boobytrap components should be removed to a safe storage or disposal area.

*e. Special Precautions.*

- (1) Be very cautious in handling delay mechanisms. Danger may exist before the appointed time because of auxiliary firing devices. All complicated and confusing devices should be destroyed in place or marked for treatment by specialists.
- (2) Wood or cardboard explosive containers, buried for long periods of time, are dangerous to disturb. They are also extremely dangerous to probe if in an advanced state of decomposition. Deteriorated high explosives are especially susceptible to detonation. Thus, a boobytrap destroyed in place and in a concentrated area long exposed to moisture may detonate many others simultaneously.
- (3) Metallic explosive containers are often dangerous to move after prolonged burial. They may also be resistant to detection because of oxidation. The explosive may become contaminated after a time, further increasing the danger of handling. Explosives containing picric acid are particularly dangerous; deterioration from contact with metal forms extremely sensitive salts which are readily detonated by handling.
- (4) Certain types of fuzes become extremely sensitive to disturbance after exposure to wet soil. Detonation in place is the only safe method of neutralizing or removing such deteriorated boobytraps.

**SELECTED VIET CONG**

**EQUIPMENT AND EXPLOSIVE DEVICES**

9

**Stick Hand Grenade**

**GENERAL DESCRIPTION AND COMMENT**

The stick hand grenade, used extensively by the Viet Cong, comes in several sizes—differentiated by lengths of handle and sizes of fragmentation heads. This grenade functions by a pull string enclosed in the handle and attached to a copper wire coated with a match compound. Normally the match compound ignites a 4-second delay element, but a number of these grenades have been found with no delay element.

**CHARACTERISTICS**

Type -----	Defensive
Color -----	Black
Maximum diameter -----	2 in
Length -----	6 to 8 in
Total weight -----	3 lb
Filler -----	TNT
Fuze delay -----	Approx 4 sec

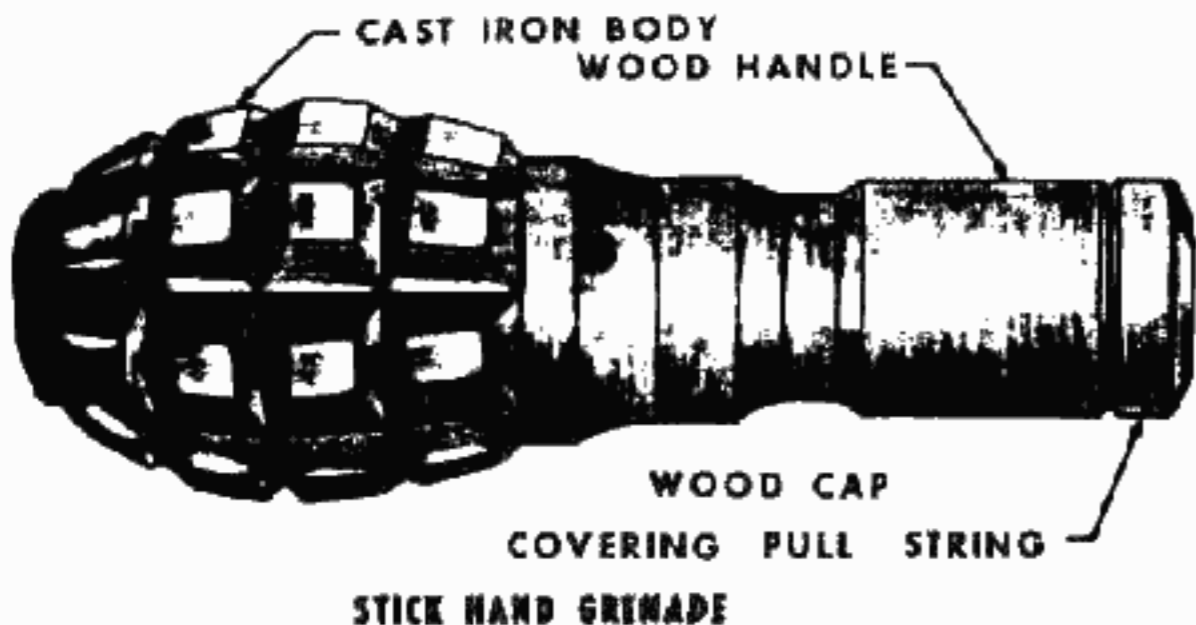

11

**Defensive Hand Grenade**

**GENERAL DESCRIPTION AND COMMENT**

The defensive hand grenade, of serrated cast iron, functions in the same manner as similar U. S. hand grenades. When the safety pin is removed and the grenade thrown, the safety lever releases the spring of the mechanical firing device which ignites the primer and delay element of the fuze.

**CHARACTERISTICS**

Type -----	Defensive
Color -----	Black
Diameter -----	2.5 in
Length -----	5 in
Total weight -----	1.5 lb
Filler -----	TNT
Fuze delay -----	Approx 4 sec

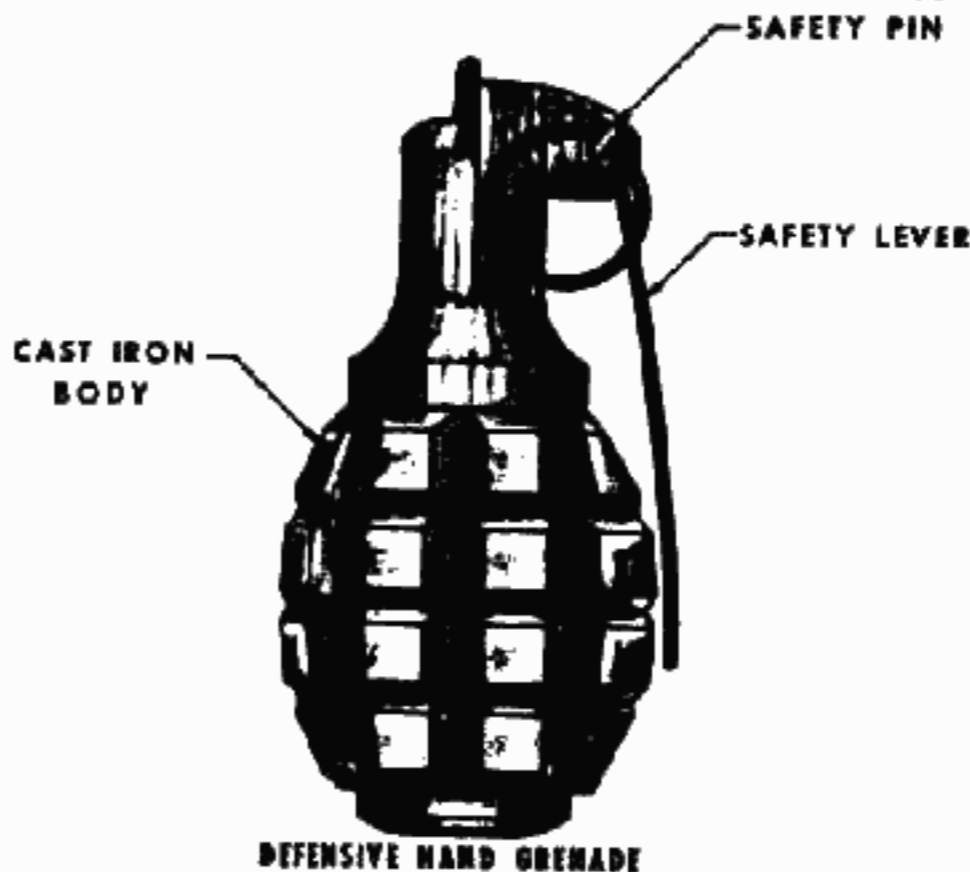

**Offensive Hand Grenade**

**GENERAL DESCRIPTION AND COMMENT**

The offensive hand grenade is made of explosive and sheet metal with crimped and soldered seams. It is normally equipped with a time delay fuze. These grenades must never be disassembled as a number of them have been found boobytrapped; for example, they have been found with an instantaneous (no delay) fuze, and an attempt to throw such a grenade, after pulling the pin, would prove fatal to the thrower.

**CHARACTERISTICS**

Type -----	Offensive
Color -----	Generally black or olive-drab
Maximum diameter -----	2.5 in
Length -----	5.4 in
Total weight -----	1.6 lb
Filler -----	TNT or potassium chlorate
Fuze delay -----	Approx 4 sec



OFFENSIVE HAND GRENADE

**Milk Can Hand Grenade**

**GENERAL DESCRIPTION AND COMMENT**

The milk can hand grenade is made from a commercial powdered milk can by cutting a hole in one end and removing most of its contents, refilling the can with cast TNT, and installing a pull-friction fuze from a stick hand grenade. Because the device has no booster charge, it uses two detonators for more powerful concussion.

**CHARACTERISTICS**

Type -----	Offensive
Color -----	Commercial label
Maximum diameter -----	3.5 in
Length -----	6.0 in
Total weight -----	2 lb
Filler -----	Cast TNT
Fuze delay -----	Approx 4 sec

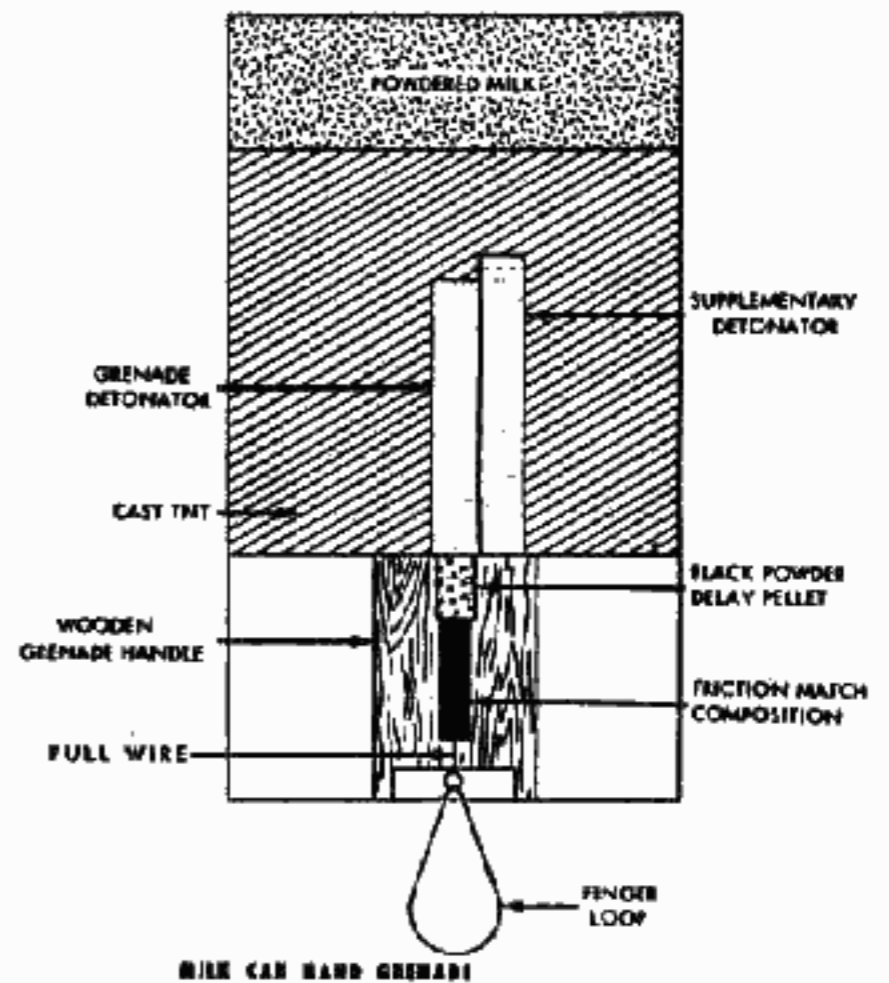

MILK CAN HAND GRENADE

**Shaped Charge Hand Grenade**

**GENERAL DESCRIPTION AND COMMENT**

The shaped charge hand grenade consists of a shaped charge, a cylindrical sheet metal charge container, a conical sheet metal drag, an impact fuze mechanism, and a wood handle with a sheet metal drag lock and pin. When the lock pin is removed and the grenade is thrown, a spring forces the conical drag back over the handle to stabilize the grenade's flight (drag is attached to charge container by strips of material inside the cone). When the grenade strikes, the impact fuze ignites the shaped charge.

**CHARACTERISTICS**

Type -----	Shaped charge (HEAT)
Color -----	Black or olive-green
Maximum diameter -----	3 in
Length -----	8.75 in
Total weight -----	Approx 1.5 lb
Filler -----	Cast TNT
Fuze delay -----	Time of flight



**Shell Case Mine**

**GENERAL DESCRIPTION AND COMMENT**

The shell case mine has a standard artillery shell casing, mostly 75-, 105-, and 155-mm calibers. A variety of fuzeing mechanisms can be improvised for this mine; the mine illustrated is detonated by the potato masher grenade inserted into the explosive charge. Inserted into the side of the casing are two fuze wells through which electrically or mechanically initiated fuzes may be placed. The mine, generally used in an antipersonnel role, is initiated by a tug on a tripwire strung across a path.

**CHARACTERISTICS**

Type -----	Antipersonnel
Color -----	Brass
Maximum diameter -----	6 in
Length -----	18 to 24 in
Total weight -----	10 to 15 lb
Filler -----	TNT
Fuze delay -----	3 to 4 sec (with grenade)

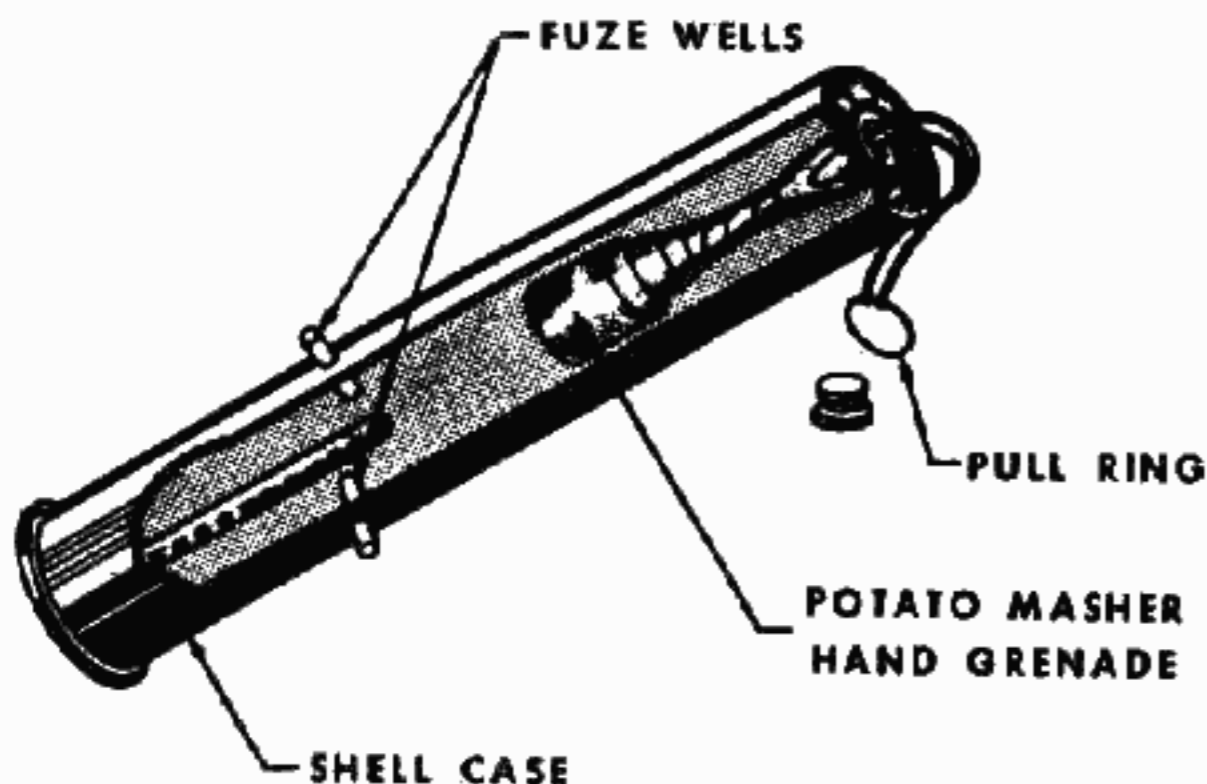

**SHELL CASE MINE**  
21  
Tin Can Antipersonnel Mine

**GENERAL DESCRIPTION AND COMMENT**

The tin can mine is constructed from a sheet metal container similar in appearance to a beer can. The firing device for the explosive is an improvised fuze with zero delay action. A hand grenade fuze may be used with this munition by removal of the delay element. The mine functions by a tripwire attached to the pull ring device, which when removed allows the spring-driven striker to move downward, hitting the primer and detonating the mine.

**CHARACTERISTICS**

Type -----	Antipersonnel
Color -----	Gray or green
Maximum diameter -----	3 in
Height -----	6 in
Total weight -----	Approx 2 lb
Filler -----	TNT
Fuze delay -----	None

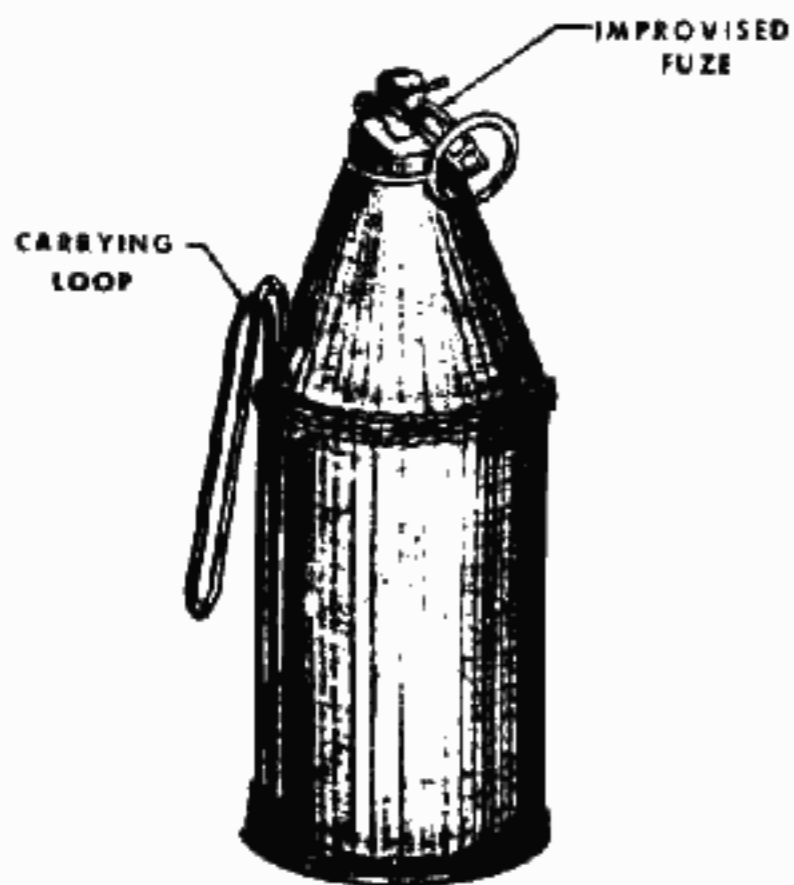

**TIN CAN ANTI-PERSONNEL MINE**  
23  
Concrete Fragmentation Mine

**GENERAL DESCRIPTION AND COMMENT**

The concrete fragmentation mine is constructed of explosive encased in cylindrically shaped concrete with a flat side for stable emplacement. A 2-inch-diameter pipe on one end of the mine head serves as a carrying handle and detonator housing. The two swivels on top of the mine are used to tie it to an object. The mine's electrical detonator usually is activated remotely by means of a battery pack or hand-held generator.

**CHARACTERISTICS**

Type -----	Antipersonnel
Color -----	Gray
Length of mine body -----	10 in
Width of base -----	7 in
Height -----	6 in
Total weight -----	13 lb
Filler -----	TNT
Fuze delay -----	None

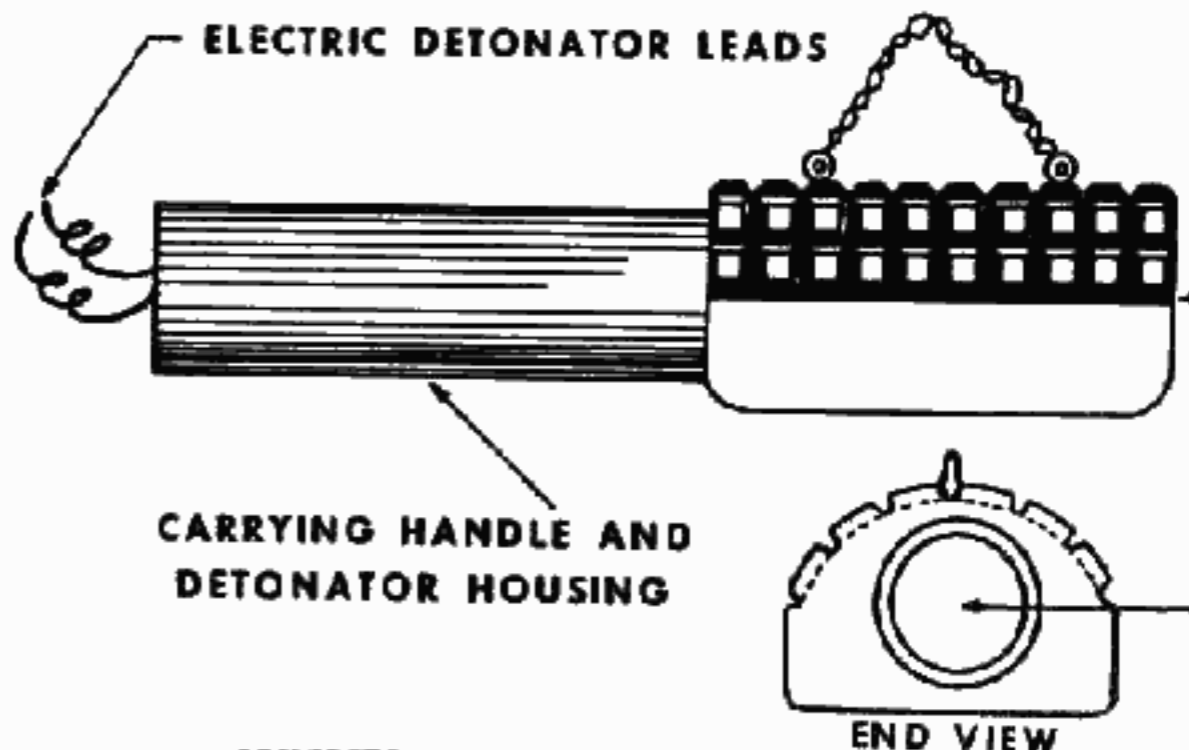

**CONCRETE FRAGMENTATION MINE**  
25  
Concrete Mound Mine

**GENERAL DESCRIPTION AND COMMENT**

The concrete mound mine is constructed of explosive encased in concrete, but possibly a similar mine of cast iron may be encountered. The mound-shaped mine is electrically fuzed and has two fuze wells, one at each end. The iron pipe at one end of the mine serves as a pole socket, as well as being a housing for one of the fuze wells. Electric current to activate the detonator is provided by a battery pack or hand-held generator.

**CHARACTERISTICS**

Type -----	Antipersonnel
Color -----	Gray
Maximum diameter -----	5.5 in
Length -----	14 in
Total weight -----	13 lb
Filler -----	TNT
Fuze delay -----	None

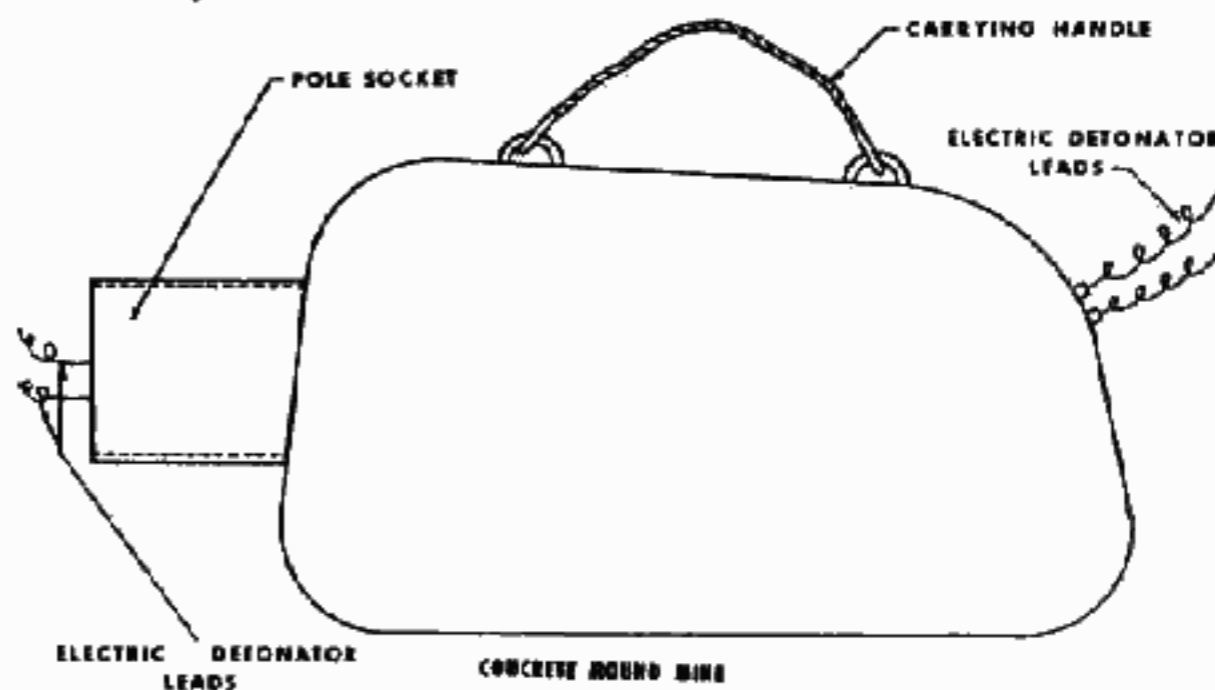

**CONCRETE MOUND MINE**  
27  
Betel Box Mine

**GENERAL DESCRIPTION AND COMMENT**

The betel box mine is constructed of concrete and explosive. Its one fuze well is located on the top at the center of the mine. Used in either an anti-personnel or an antivehicular role, the mine is exploded by an electrical detonator.

**CHARACTERISTICS**

Type -----	Antipersonnel/
Color -----	Gray antivehicular
Maximum diameter -----	8 in
Height -----	7 in
Total weight -----	13 lb
Filler -----	TNT

**CHARACTERISTICS**

Type -----	Antipersonnel
Color -----	Gray
Maximum diameter -----	5 in
Length -----	9 in
Total weight -----	12 lb
Filler -----	Melinite/TNT

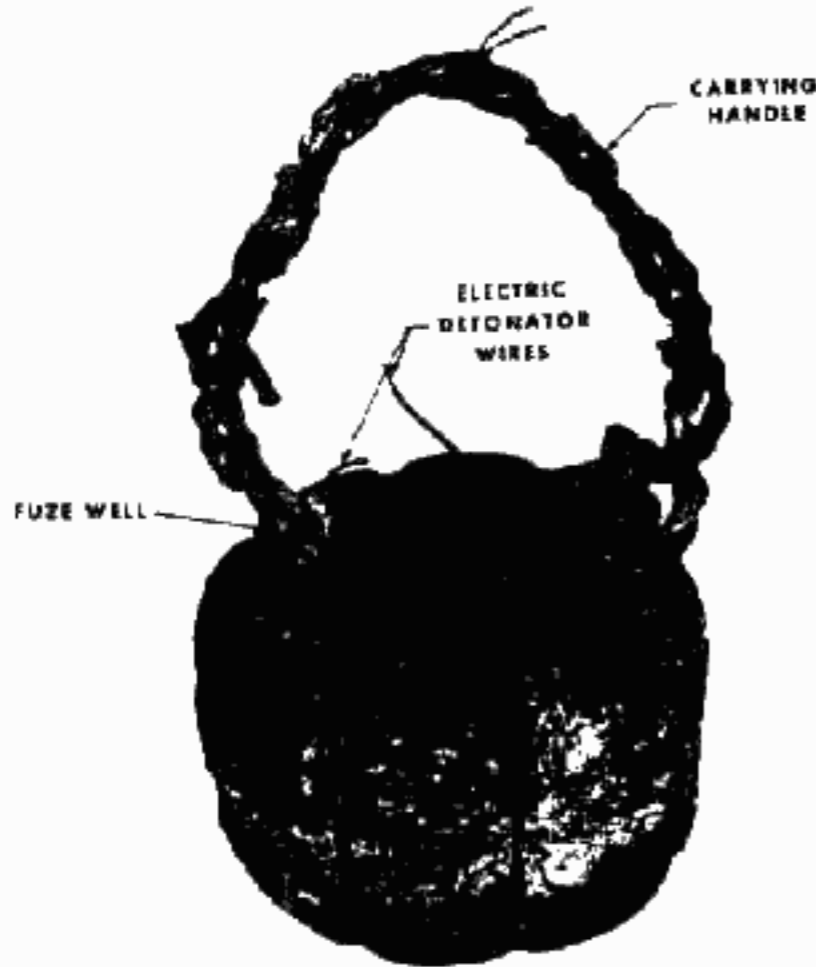

METAL BOX MINE  
29  
**Turtle Mine**

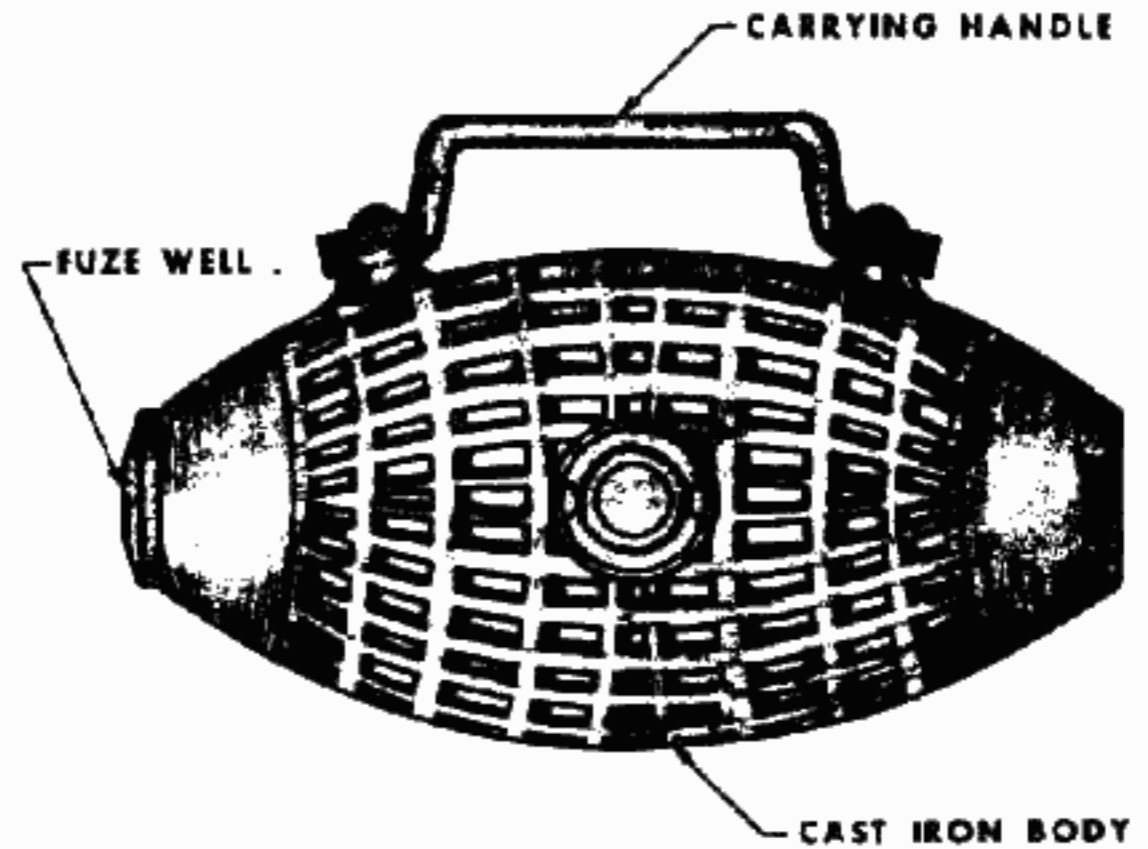

PINEAPPLE FRAGMENTATION MINE  
33  
**Dud Shell Mine**

**GENERAL DESCRIPTION AND COMMENT**

The turtle mine, constructed of concrete with explosive inside, is used primarily as a demolition charge. It can be detonated by either an electrical or mechanical fuze (with or without delay). The mine illustrated utilizes a mechanical fuze.

**GENERAL DESCRIPTION AND COMMENT**

The dud shell mine is improvised from a dud artillery or mortar projectile. The mine is made by removing the fuze from a projectile and drilling a hole into the explosive for an electrical detonator. Batteries or a hand-held generator supply the current to activate the detonator remotely. The mine is usually found along roads or trails. Its effectiveness against armored vehicles and personnel varies with the type and size of projectile used.

**CHARACTERISTICS**

Type -----	Dual purpose
Color -----	Gray
Maximum diameter -----	5 in (end view is semicircular)
Length -----	9 in
Overall weight -----	13 lb
Filler -----	TNT

**CHARACTERISTICS**

Type -----	Antipersonnel/
Color -----	Varies antivehicular
Maximum diameter -----	Varies
Length -----	Varies
Total weight -----	Varies
Filler -----	Usually TNT



TURTLE MINE  
31  
**Pineapple Fragmentation Mine**

**GENERAL DESCRIPTION AND COMMENT**

The pineapple fragmentation mine is a unique egg-shaped mine constructed of cast iron and is further identified by surface serrations and a carrying handle. The mine has a single fuze well located in one end of the body. It is fuzed with an electrical detonator which is activated by current from batteries or a hand-held generator.



**DUD SHELL MINE**

35

**Min Antipersonnel Mine**

**GENERAL DESCRIPTION AND COMMENT**

The min antipersonnel mine, made of cast iron, resembles a stick hand grenade with a very short handle. The word, "Min," is often found cast into the body. The handle houses a pull-friction, delay-type fuze. A tug on a tripwire attached to the pull wire of the friction fuze will, by extracting the pull wire, ignite the delay element.

**CHARACTERISTICS**

Type -----	Antipersonnel
Color -----	Gray to black
Maximum diameter -----	2 in
Length -----	6.5 in
Total weight -----	2.2 lb
Filler -----	TNT
Fuze delay -----	2 to 4 sec

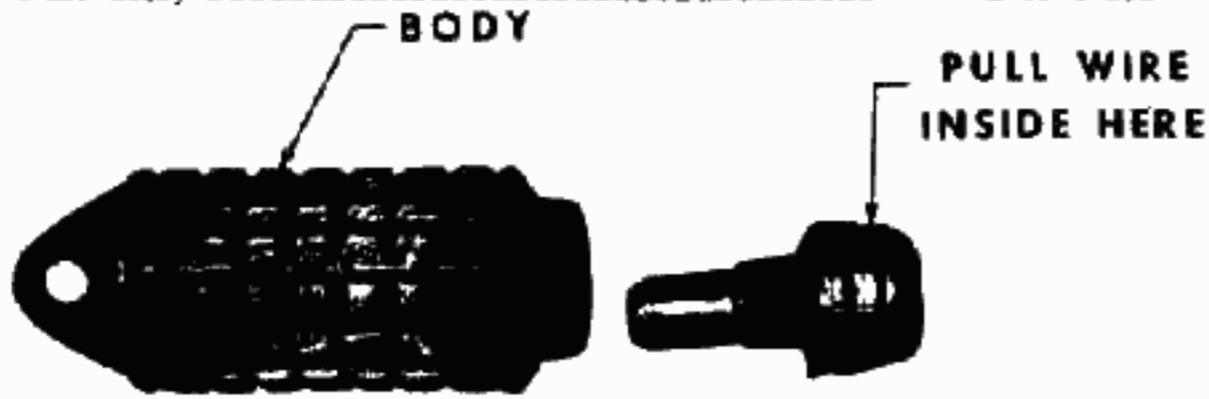

**MIN ANTIPERSONNEL MINE**

37

Bounding Fragmentation Mine

**GENERAL DESCRIPTION AND COMMENT**

The bounding fragmentation mine is improvised from U.S. M2 bounding-mine or M48 trip-flare mine cases. A wooden cylinder slightly smaller in diameter than the mine case is hollowed out so that a standard grenade (frequently the U.S. M26) can fit inside. The wooden cylinder with inclosed grenade is then fitted into the mine case and the grenade's safety pin is extracted. When the mine is initiated electrically, either by a battery pack or a hand generator, the cylinder and grenade are propelled upward. As the wooden cylinder with grenade leaves the case, the handle flies off and initiates the fuze train of the grenade.

**CHARACTERISTICS**

Type -----	Antipersonnel
Color -----	Olive-drab or gray
Maximum diameter -----	2.5 in
Height -----	8 in
Total weight -----	5 lb
Filler -----	Grenade (TNT)
Fuze delay -----	3 to 4 sec (grenade)

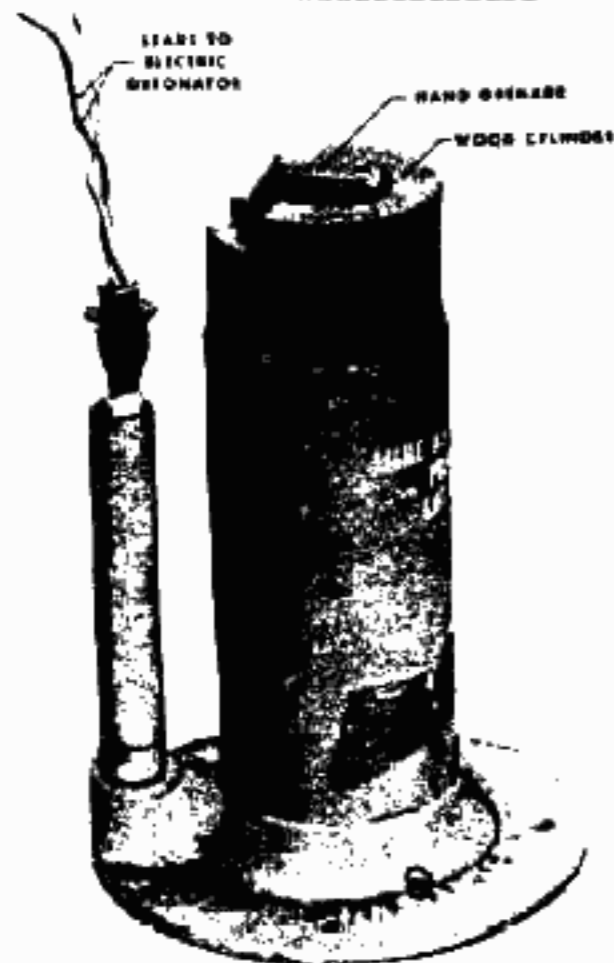

**BOUNDING FRAGMENTATION MINE**

39

**DH-10 Directional Mine**

**GENERAL DESCRIPTION AND COMMENT**

The DH-10 directional fragmentation mine is primarily an antipersonnel mine which also can be used against thin-skinned vehicles or similar items. The concave front or fragmentation face of the mine contains approximately 450 half-inch steel fragments embedded in a matrix, and is backed up by cast TNT. Designed for electrical detonation, the mine is provided with an adjustable frame so that it can be placed on various types of surfaces and aimed in any direction. The single fuze well is centered on the convex (back) side of the mine.

**CHARACTERISTICS**

Type -----	Dual purpose
Color -----	Gray to black
Maximum diameter -----	12 in
Width -----	4 in
Total weight -----	20 lb
Filler -----	Cast TNT

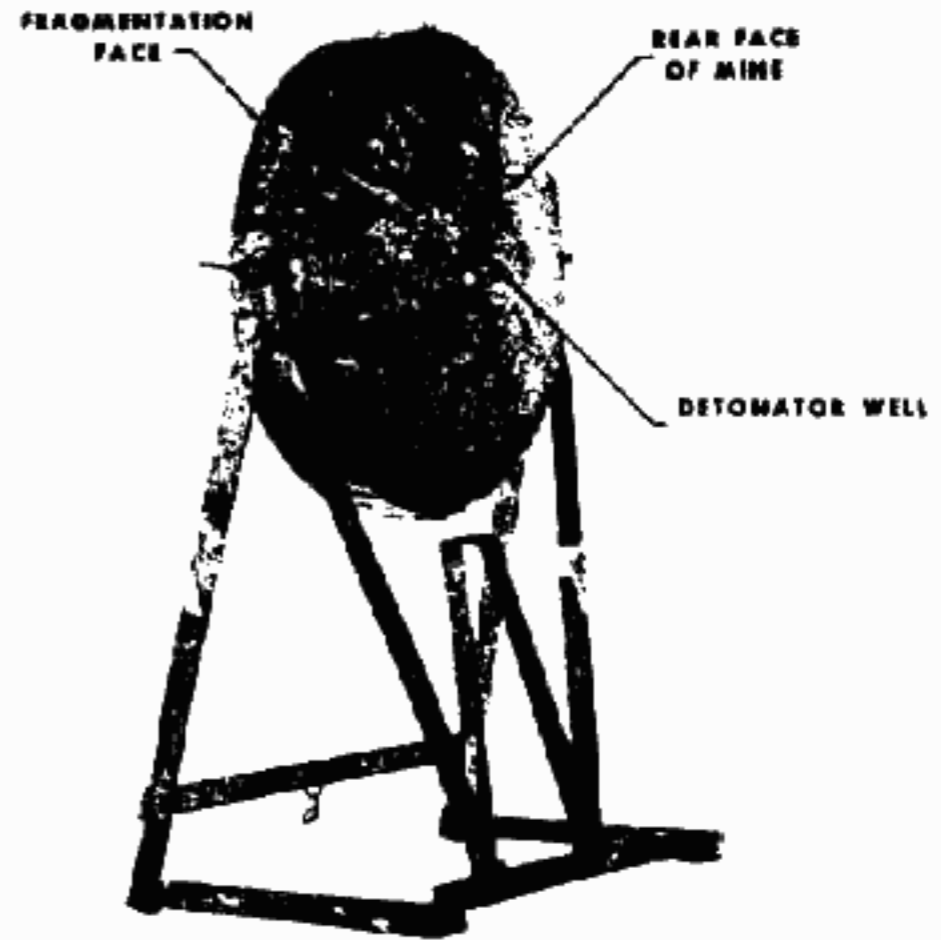

**DH-10 DIRECTIONAL MINE**

41

**Bevelled Top Water Mine**

**GENERAL DESCRIPTION AND COMMENT**

Bevelled top water mines are found in large quantities in the Mekong River and its tributaries. They are placed at depths compatible with the draft of the boats plying the particular waterway. The mine is constructed of sheet metal rolled into a conical shape; the seams are soldered or riveted. The electrical fuze is located in a fuze well in the bottom of the mine. A flotation chamber is in the end opposite the fuze well. Batteries or a hand-held generator provides the current.

**CHARACTERISTICS**

Type -----	Antibat
Color -----	Black
Maximum diameter -----	11 in
Height -----	12 in
Total weight -----	27 lb
Filler -----	TNT



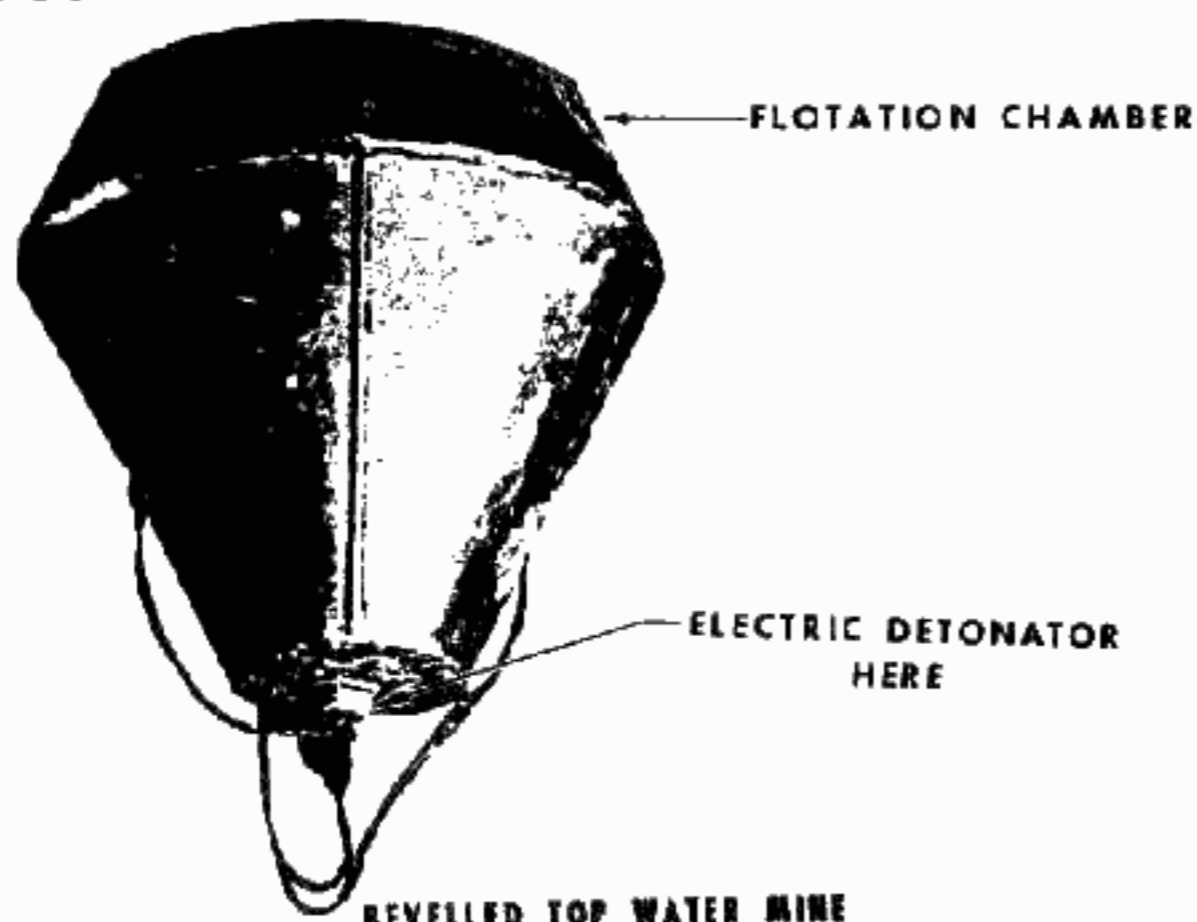

BEVELLED TOP WATER MINE

43

Truncated Cone Water Mine

GENERAL DESCRIPTION AND COMMENT

The truncated cone water mine is manufactured from medium-gage sheet metal in two sections riveted together: the explosive section with electrical fuze (small end) and the flotation chamber. When a vessel approaches, the mine is positioned by the Viet Cong on the shore by means of ropes. Once positioned, the mine is detonated by using a battery pack or a hand generator.

CHARACTERISTICS

Type	-----	Antiboat
Color	-----	Black
Maximum diameter	-----	17 in
Height	-----	25 in
Total weight	-----	83 lb
Filler	-----	TNT

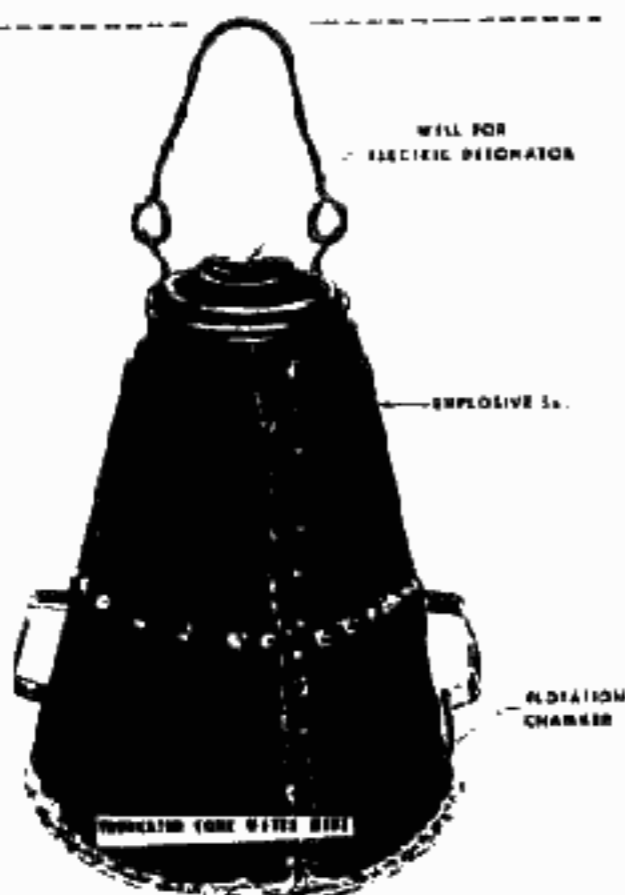

45

Small Truncated Cone-Shaped Charge

GENERAL DESCRIPTION AND COMMENT

The small truncated cone-shaped charge is encased in sheet metal plates riveted together. A pull-friction fuze in the small end usually initiates the explosive charge; it contains a delay element which allows the Viet Cong saboteur to leave the vicinity before the explosion. Some charges have also been found with electrical detonators and some with boobytraps in the fuze mechanism.

CHARACTERISTICS

Color	-----	Usually black
Maximum diameter	-----	8 to 10 in
Height	-----	8 to 10 in
Total weight	-----	15 to 18 lb
Filler	-----	TNT or homemade explosive
Fuze delay	-----	Approx 9 sec (pull-friction)

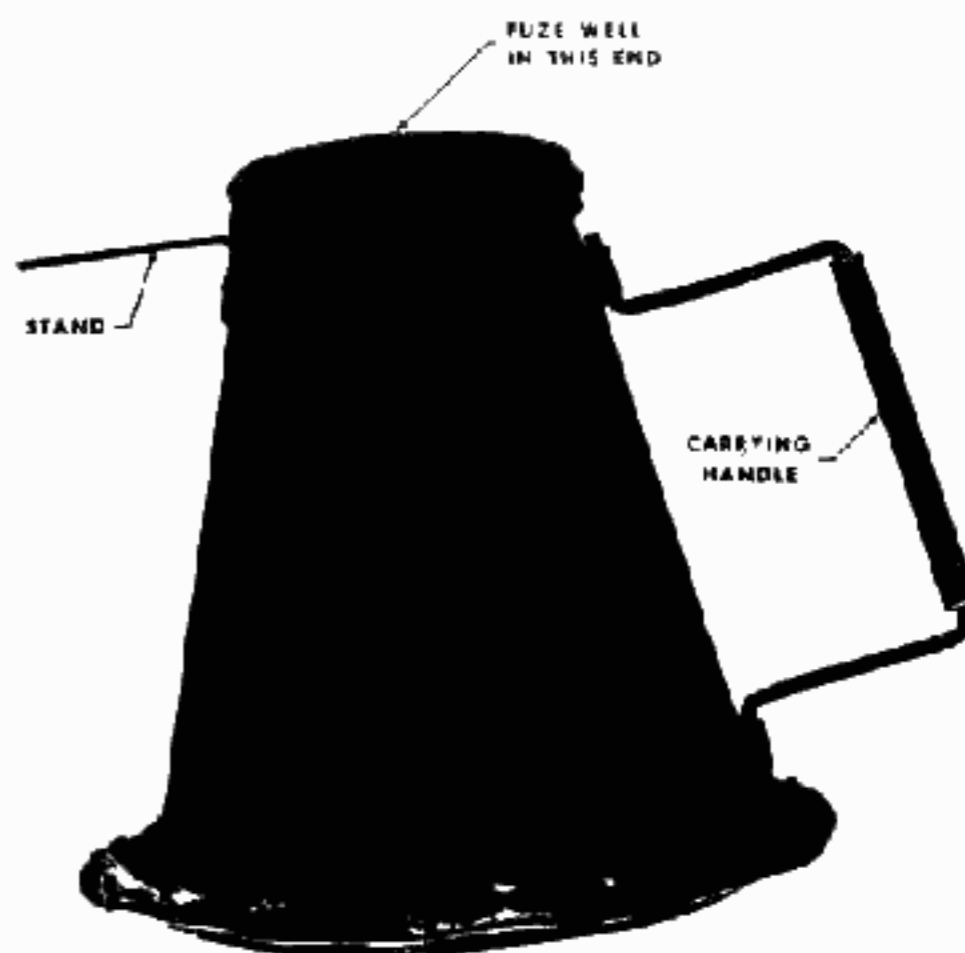

SMALL TRUNCATED CONE SHAPED CHARGE

47

Large Truncated Cone-Shaped Charge

GENERAL DESCRIPTION AND COMMENT

The large truncated cone-shaped charge is encased in heavy-gage sheet metal with welded seams. Its fuze is a pull-release or pull-friction device of unknown construction, which is initiated when a nearby Viet Cong tugs on the pull wire. This charge is also found to be occasionally fuzed for electrical initiation.

CHARACTERISTICS

Color	-----	Unpainted or black
Maximum diameter	-----	9 in
Height	-----	11 in
Total weight	-----	22 lb
Filler	-----	TNT



LARGE TRUNCATED CONE-SHAPED CHARGE

49

Turtle Charge

GENERAL DESCRIPTION AND COMMENT

The turtle charge is encased in four pieces of sheet metal riveted together and coated with a black waterproofing compound. This charge can be initiated either electrically or mechanically (with or without a delay element). Either type of fuze would be located in the fuze well on the side of the charge and would be initiated by a nearby Viet Cong.

**CHARACTERISTICS**

Color .....	Black
Length .....	Approx 4 in
Width .....	9 in
Height .....	5 to 6 in
Total weight .....	20 lb
Filler .....	Picric acid (melinite) or TNT



TIME FUZE  
WRAPPED EXPLOSIVE CHARGE  
POLE CHARGE  
55  
Oil Drum Charge

**GENERAL DESCRIPTION AND COMMENT**

The oil drum charge is made by partially filling a standard U.S. 5-gallon oil or lubricant drum with explosive and installing a wristwatch firing device (see page 63) in the bottom end. The specimen shown on the opposite page actually has two firing devices to insure that the charge will explode even if one fuze malfunctions.

**CHARACTERISTICS**

Color .....	Olive-drab
Maximum diameter .....	11 in
Height .....	13 in
Total weight .....	Approx 25 lb
Filler .....	Varies

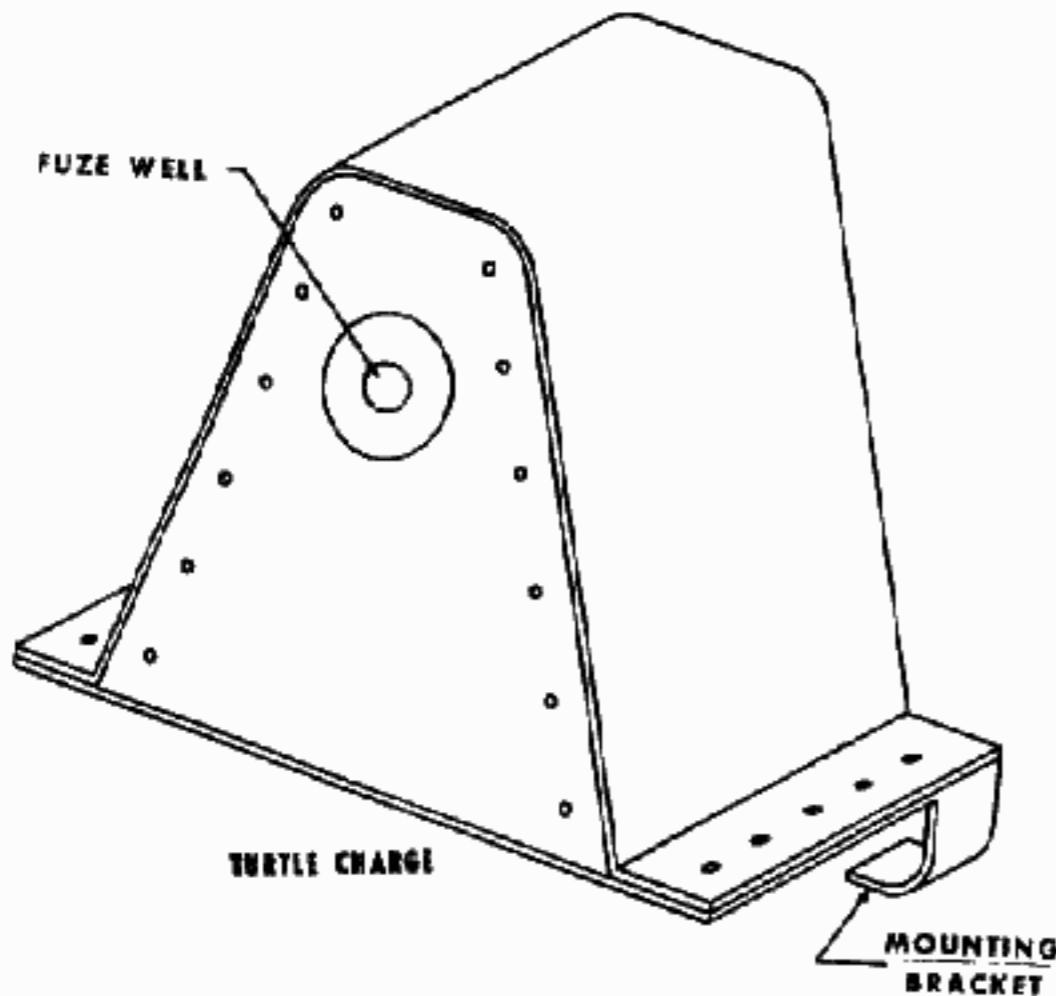

TURTLE CHARGE  
FUZE WELL  
MOUNTING BRACKET

51  
Cylindrical Charge

**GENERAL DESCRIPTION AND COMMENT**

The cylindrical charge, although normally encased in sheet metal as illustrated, can also be made from artillery and mortar projectile shipping containers. The dimensions and weight vary considerably. The charge is normally fired electrically by a nearby Viet Cong using batteries or a hand-held generator. The weapon could also be fired by pull-friction, mechanical, or delay-type firing devices.

**CHARACTERISTICS**

Color .....	Varies
Maximum diameter .....	Varies
Length .....	Varies
Total weight .....	5 to 25 lb
Filler .....	TNT, potassium chlorate, or homemade explosive

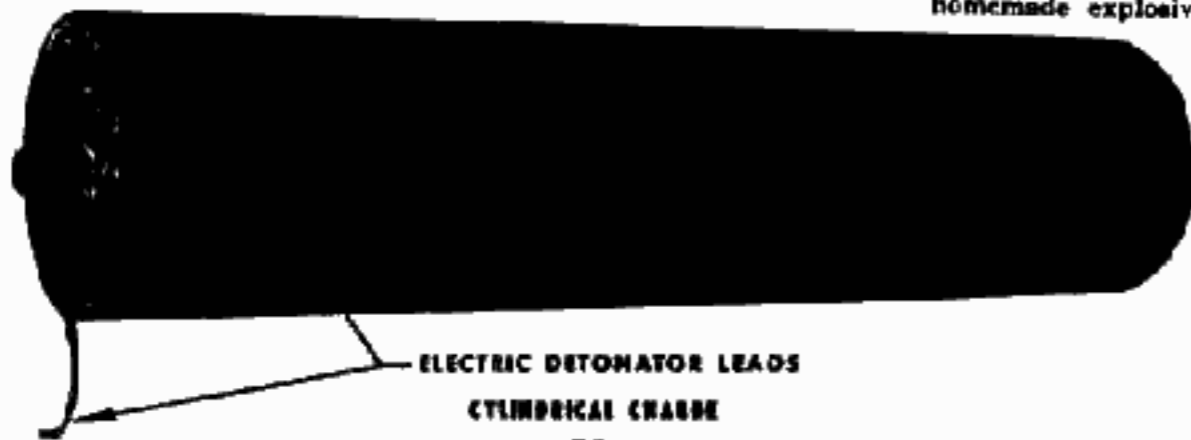

ELECTRIC DETONATOR LEADS  
CYLINDRICAL CHARGE  
53  
Pole Charge

**GENERAL DESCRIPTION AND COMMENT**

The pole charge consists of a quantity of explosive wrapped in waterproof material (such as a piece of tarpaulin or canvas) and lashed to a 3- or 4-foot-long pole. The explosive is initiated by a piece of time fuze crimped to a nonelectric detonator. Pole charges are generally used during assaults for destroying barbed wire entanglements and bunkers.

**CHARACTERISTICS**

Color .....	Varies
Maximum diameter .....	Varies
Length (pole) .....	3 to 4 ft
Total weight .....	8 to 15 lb
Filler .....	Normally potassium chlorate
Fuze delay .....	Varies

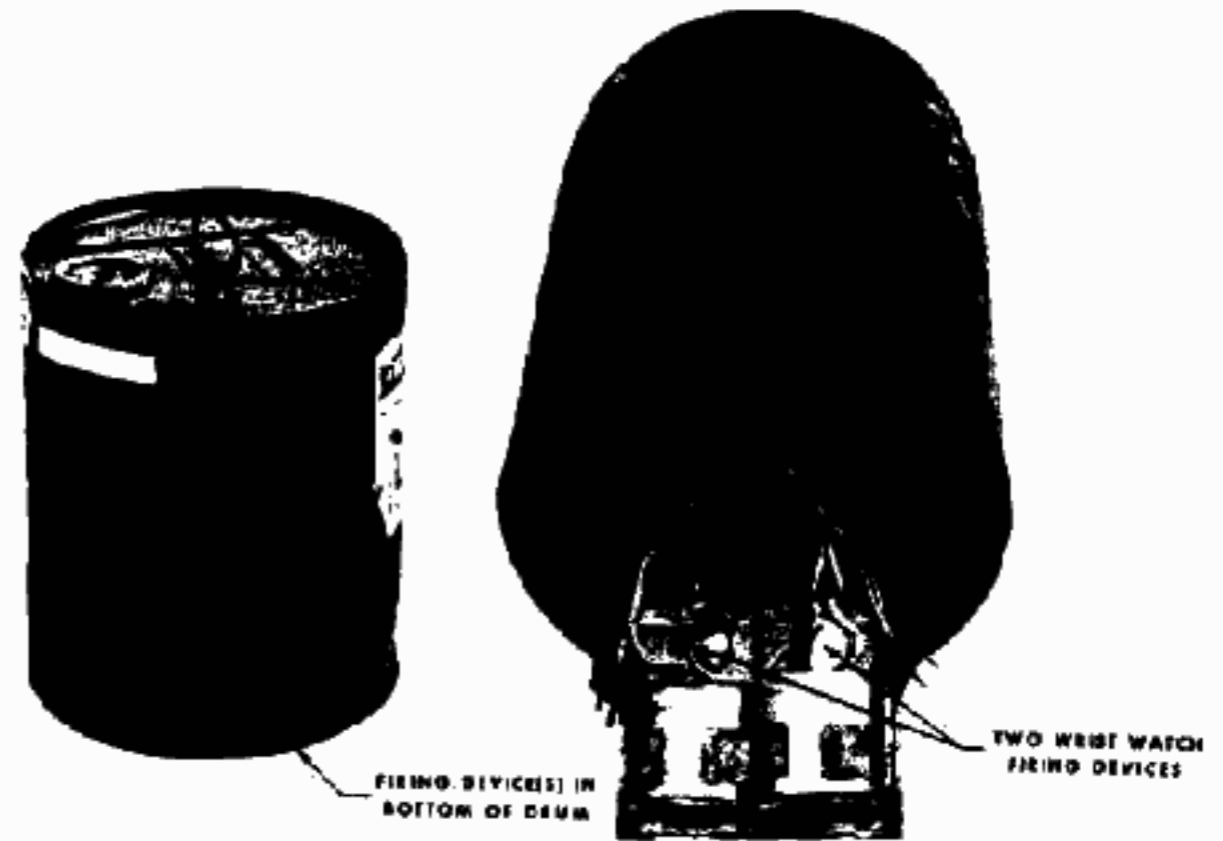

DRUM CHARGE  
57

Bangalore Torpedo

**GENERAL DESCRIPTION AND COMMENT**

The Bangalore torpedo is generally made from a length of 2-inch-diameter pipe filled with explosive and initiated by a fuze. The specimen illustrated is one of the better made items and has a fuze well in one end. The most commonly encountered Bangalore torpedoes are much cruder in appearance. They may be found with any type of fuze.

**CHARACTERISTICS**

Color .....	Black or olive-drab
Maximum diameter .....	2 in
Length .....	Approx 42 in
Total weight .....	Varies
Filler .....	TNT or picric acid



BANGALORE TORPEDO

59  
Chemical Fuze

GENERAL DESCRIPTION AND COMMENT

The chemical fuze is used for sabotage. It can be attached to any mine or demolition charge. The fuze is initiated by breaking the corrosive liquid vial; the corrosive solution then gradually corrodes the wire which restrains the firing pin. When the wire has weakened sufficiently, the firing pin is released and strikes the primer, detonating the charge. The delay time provided by this fuze varies with temperature and wire diameter.

CHARACTERISTICS

Type -----	Delay
Diameter -----	0.5 in
Length -----	5 in
Fuze delay -----	Varies; 20 to 38 min

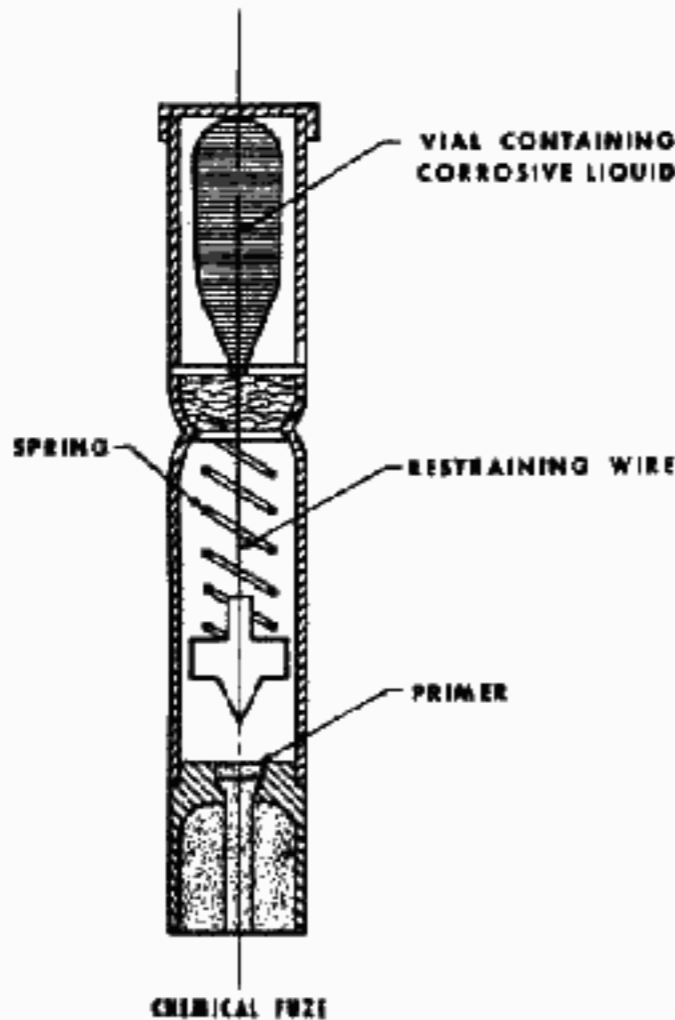

61

Pressure-Electric Firing Device

GENERAL DESCRIPTION AND COMMENT

The pressure-electric firing device consists of a wood frame; a movable, spring-loaded wooden pressure piece attached to a bolt; and a length of double-strand electric wire. One strand of electric wire is attached to the bolt; the second strand (bare) is fastened to the frame. When some outside force (i.e. a person stepping on the device) pushes the pressure piece down so that the head of the bolt contacts the bare strand of wire, the circuit is completed through the electrical detonator which then fires the device.

CHARACTERISTICS

Type -----	Nondelay
Length -----	Approx 4.5 in
Width -----	Approx 1.5 in
Height -----	Approx 4 in
Operating force -----	Varies widely

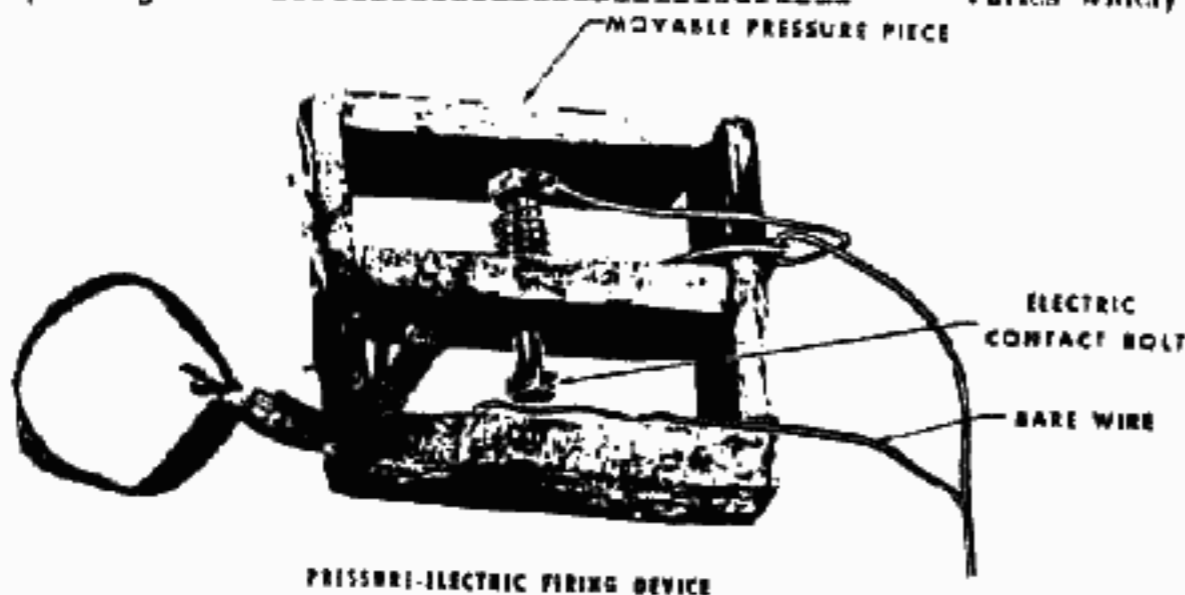

63  
Wristwatch Firing Device

GENERAL DESCRIPTION AND COMMENT

The wristwatch firing device is used to provide a delay between the time an explosive charge (bomb or mine) is placed and the time it explodes. The delay period can range from a few minutes to 12 hours according to how the watch is altered and set. Either the minute hand (if the desired delay is in hours) or the hour hand (if the desired delay is in minutes) is broken off. One electric lead is connected to the stem or case of the watch and the second lead is connected to a screw passing through a hole in the watch crystal. The watch runs for a preset interval until its remaining hand touches the screw; at that time the circuit is completed and an electrical detonator explodes. The illustration shows an actual installation including the power supply; the inset shows a watch only, in schematic form.

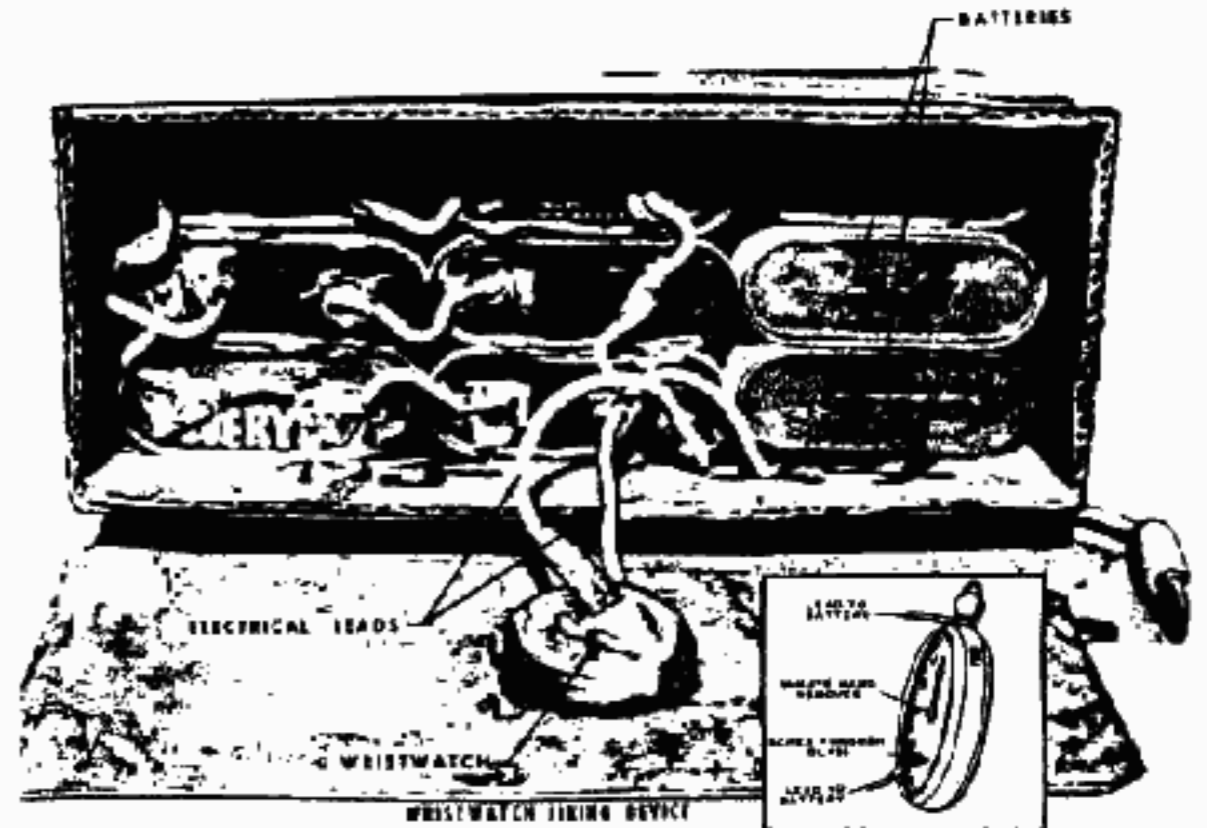

65

Mousetrap Firing Device

GENERAL DESCRIPTION AND COMMENT

The mousetrap firing device, as its name indicates, consists of an ordinary mousetrap, arranged so that the yoke, when tripped, will drive a firing pin (nail) into a percussion primer. This firing device has been frequently used on Viet Cong improvised guns. Its future use will probably be confined to boobytrap or antipersonnel mine installations.

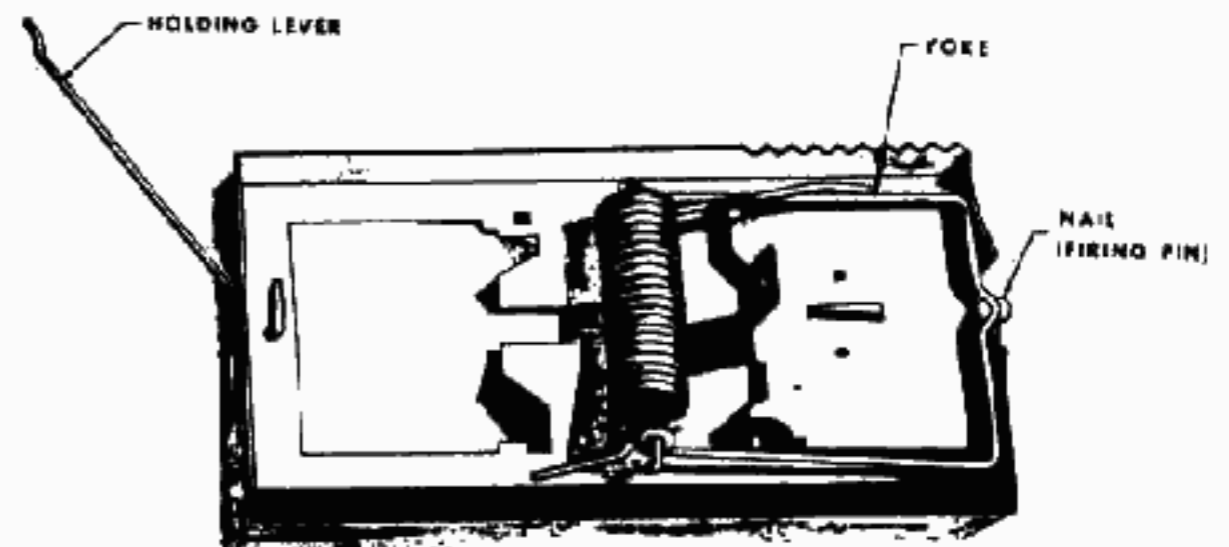

MOUSETRAP FIRING DEVICE

67

Angled Arrow Trap

GENERAL DESCRIPTION AND COMMENT

The angled arrow trap is made of a piece of bamboo (about 1-meter long) fastened to a board, a steel arrow, a strong rubber band, a tripwire, and a catch mechanism. The device is placed in a camouflaged pit, the bottom of which is sloped in such a way that a person tripping the wire will be struck in the thorax by the arrow.



ANGLED ARROW TRAP

69  
Whip

GENERAL DESCRIPTION AND COMMENT

The whip consists of a length of green bamboo, supported by a series of posts, and three or four barbed-point arrows. The bamboo pole is bent and held in an arc position by a catch device. When a tripwire placed across a trail or path is pulled, it releases the catch device, and the bamboo pole hurls the arrows along the path at about chest height.

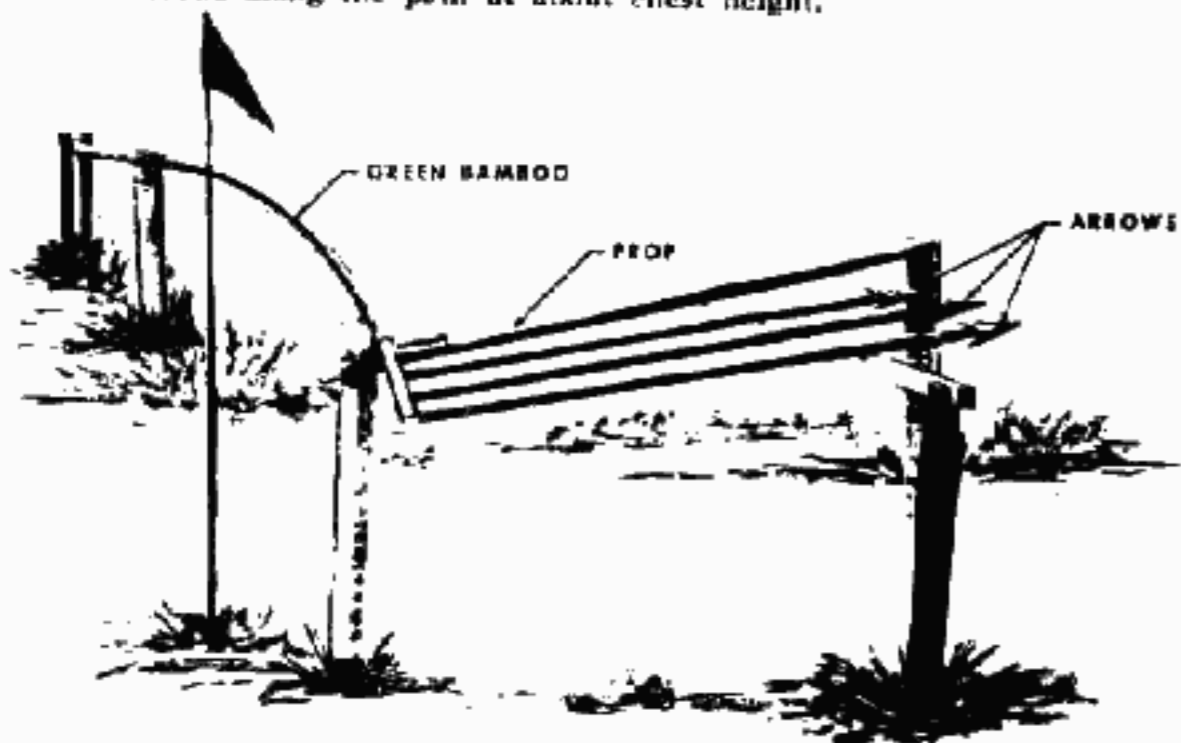

WHIP  
71  
Bicycle Mine

GENERAL DESCRIPTION AND COMMENT

The bicycle mine is made from an ordinary bicycle by filling part of the tubular frame with explosive, installing an electrical detonator in this explosive, and connecting the detonator to batteries and a wristwatch firing device (see page 63) in the headlight housing. The bicycle explodes when, after a preset time interval, the wristwatch hand touches an electric contact and the circuit through the detonator is completed. This mine can be varied by connecting the detonator directly to the headlamp power generator; when the bicycle is moved, the generator sends an electric current through the detonator to cause the explosion.

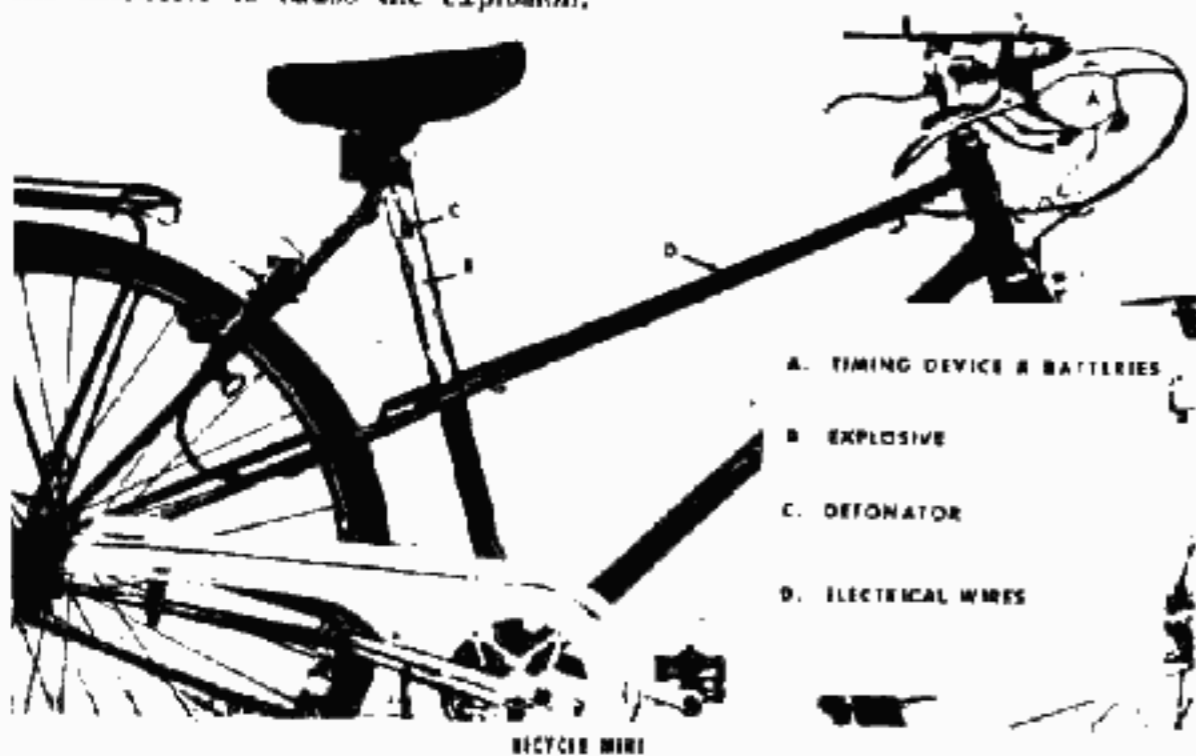

BICYCLE MINE

73

Cartridge Trap (Foot Breaker)

GENERAL DESCRIPTION AND COMMENT

The cartridge trap consists of a cartridge set into a piece of bamboo fastened to a board and installed in a camouflaged pit. A nail driven through the bottom of the bamboo serves as a firing pin. The weight of a man stepping on the upper end of the cartridge forces the nail into the cartridge to initiate the primer; the bullet is then propelled upward through the man's foot.

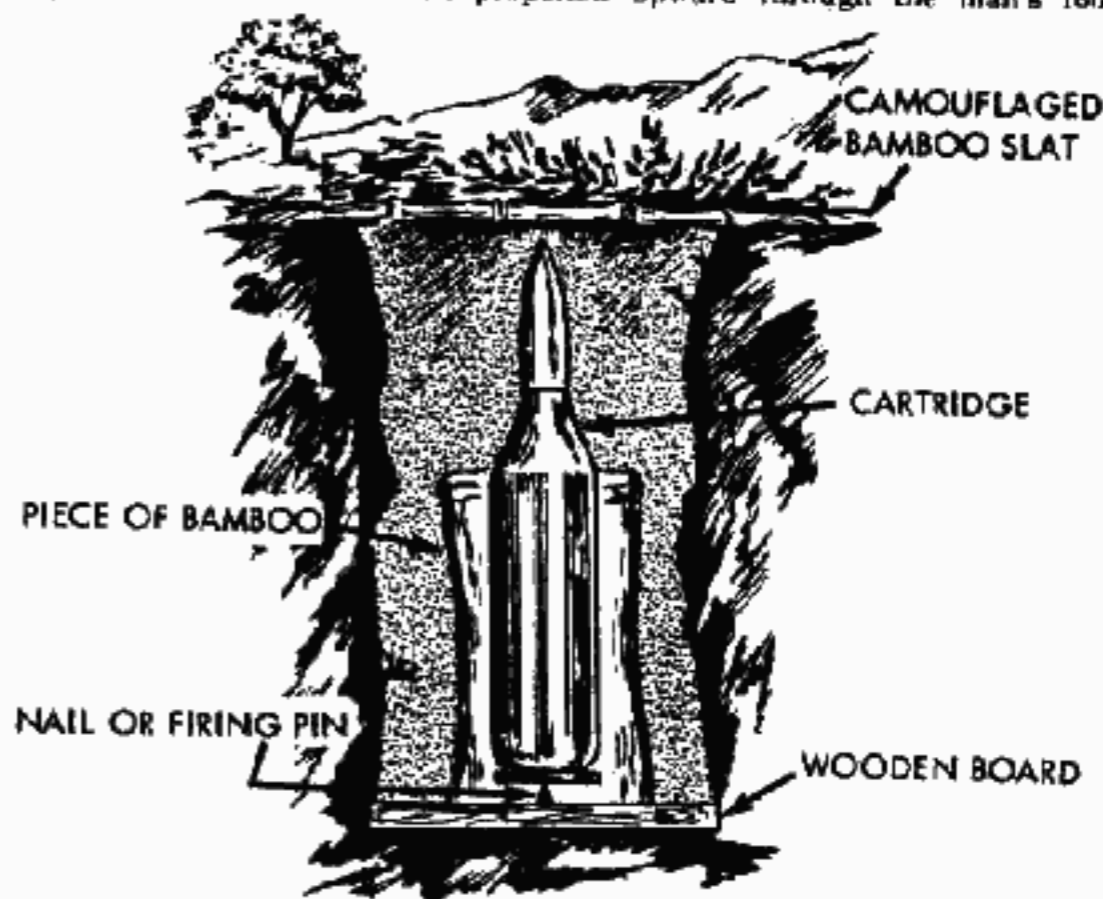

CARTRIDGE TRAP (FOOT BREAKER)

75

Spike Board Pit

GENERAL DESCRIPTION AND COMMENT

The spike board pit is simply a small pit the bottom of which is lined with boards through which spikes have been driven. The top of the pit is camouflaged. A person stepping on the camouflage material falls into the pit and impales his foot or feet on the spikes. These pits are generally about 18 inches square and 12 inches deep.



SPIKE BOARD PIT

77

Tilting Lid Spike Pit

GENERAL DESCRIPTION AND COMMENT

The tilting lid pit is substantially the same type of trap as the spike board pit described on page 75. The major differences are that it is much larger (about 13 feet square by 8 feet deep) and has a pivoting lid. The lid is supported in the middle by an axle; when locked in position it is strong enough to support a man's weight. When the lid is not locked, it pivots when a man steps on it and the man drops into the pit onto the boards with spikes that cover the bottom. The lid, which is counterbalanced, then swings back to its original position. Because of the pit's depth, the walls are shored up with boards or logs to prevent cave-ins.

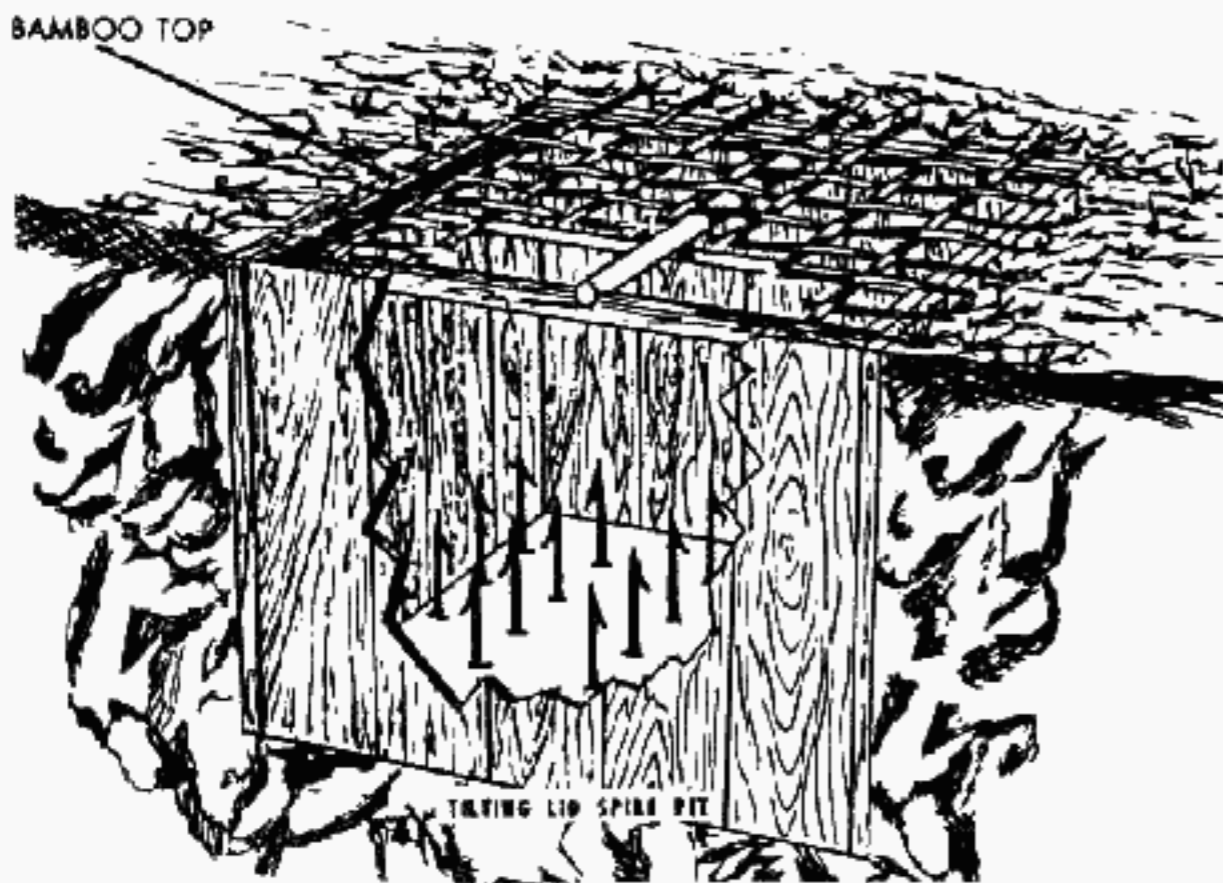

79  
Pivoted Spike Board

**GENERAL DESCRIPTION AND COMMENT**

The pivoted spike board is used with a foot pit. When a person steps on the treadle (shown in the illustration), the board with driven spikes pivots about an axle. As the victim drops into the pit, the spike board strikes him in the chest or face.

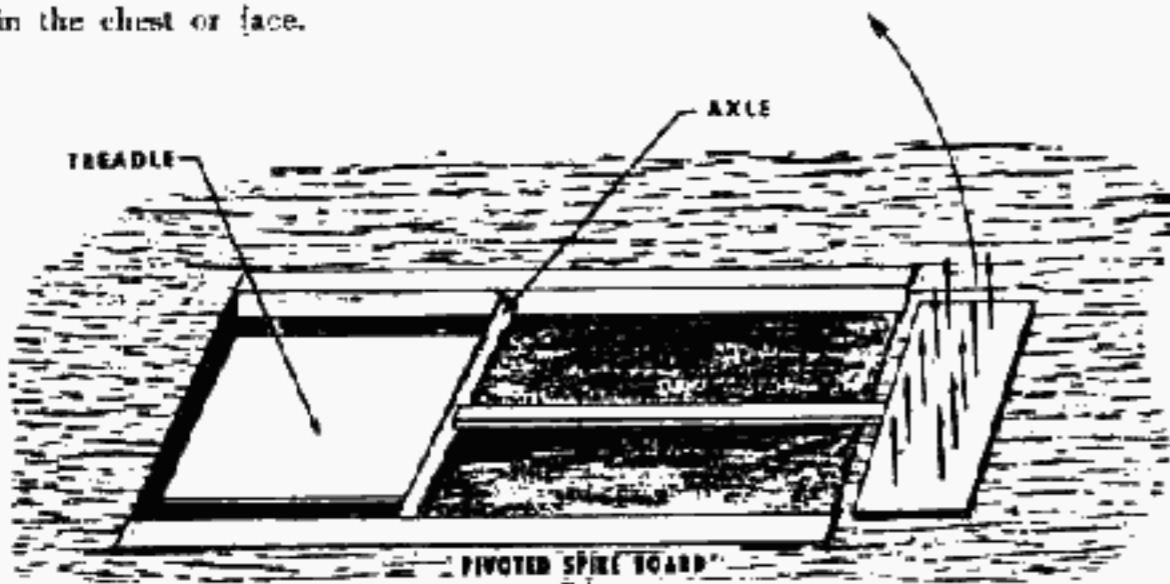

81  
Venus Flytrap (Pit)

**GENERAL DESCRIPTION AND COMMENT**

The Venus flytrap (pit) consists of a rectangular framework with overlapping barbs emplaced over a pit on trails or in rice paddies. The dimensions of such devices vary; the one illustrated is approximately 8 by 22 inches. The barbs are angled downward toward the pit, thus making any attempt to extract a leg exceedingly difficult. If a person steps into one of these flytraps, he should cautiously bend the barbs down or cut them before attempting to pull his leg out.



83  
Venus Flytrap (Can)

**GENERAL DESCRIPTION AND COMMENT**

The Venus flytrap (can) is a variation of the Venus flytrap (pit) described on page 81. The flytrap illustrated is constructed of a metal container. An individual trapped in one of these devices should cut off or bend the barbs downward before making any attempt to withdraw his leg.

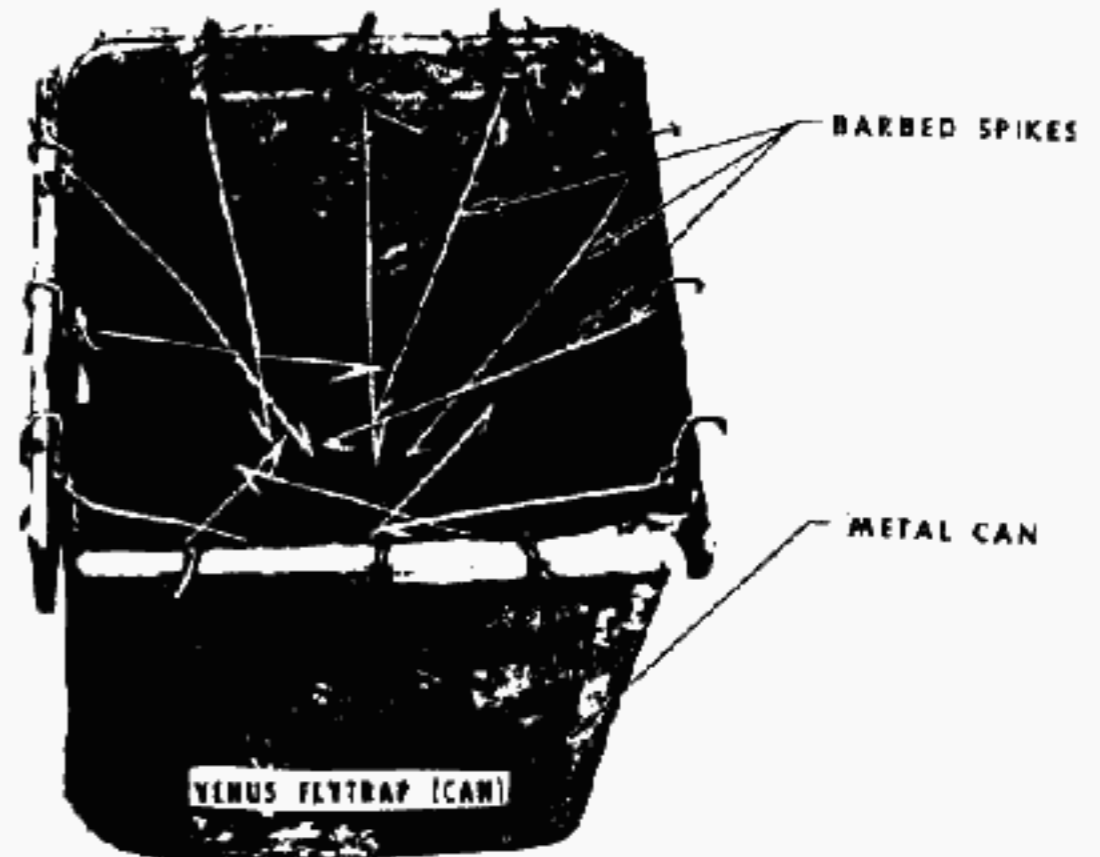

85  
Sideways Closing Trap

**GENERAL DESCRIPTION AND COMMENT**

The sideways closing trap, another variety of the spike trap, consists of two wood strips, each studded with barbed spikes, sliding along a pair of guide rods and sprung together by two large rubber bands cut from an automobile inner tube. A wooden prop keeps the spike-studded wood strips apart and stretches the rubber bands. The device is placed in the top of a pit (about 4 feet deep) and camouflaged. As a man steps on this device, he dislodges the prop, whereupon the rubber bands, no longer stretched taut, clamp the spike strips around him. The spikes rake his legs, abdomen, and chest until he stops falling. A variation of this device consists of a length of green bamboo split lengthwise, instead of wood strips, with spikes along each side of the split.



87  
Trap Bridge

**GENERAL DESCRIPTION AND COMMENT**

The trap bridge is a wooden bridge boobytrapped by partially sawing through the planks and camouflaging the cut with mud. Barbed stakes are laid underneath the bridge and along the adjacent banks; anyone crossing the bridge causes it to collapse and he or they will be impaled on these spikes.

BRIDGE FLOOR IS CUT AT THE MIDDLE AND COVERED WITH MUD

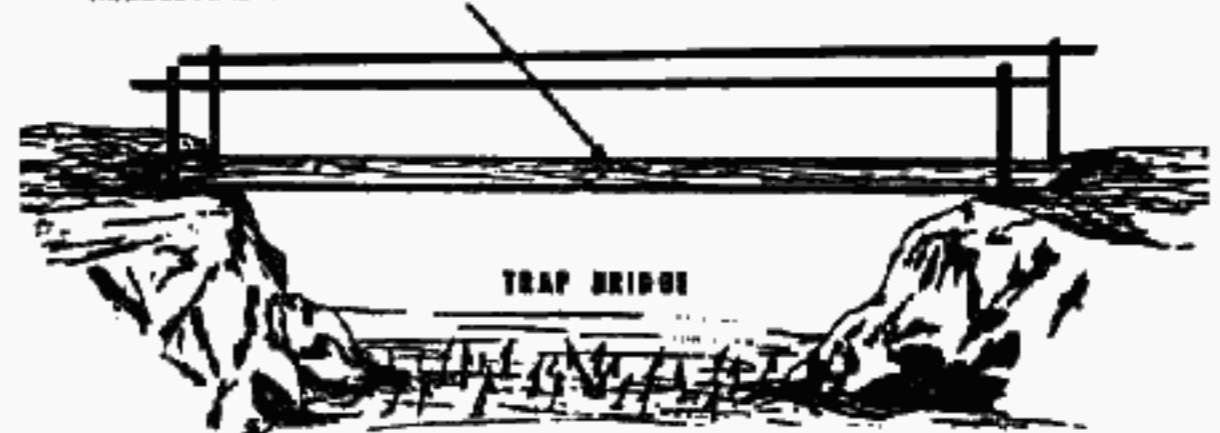

89

Suspended Spikes

GENERAL DESCRIPTION AND COMMENT

The suspended spikes device, also known as the Tiger Trap, consists of an 18-inch-square board with spikes. It is weighted with bricks and suspended from the branch of a tree overhanging a path. A tripwire stretched across the path beneath the spike board, when pulled, frees the device to fall on someone below.

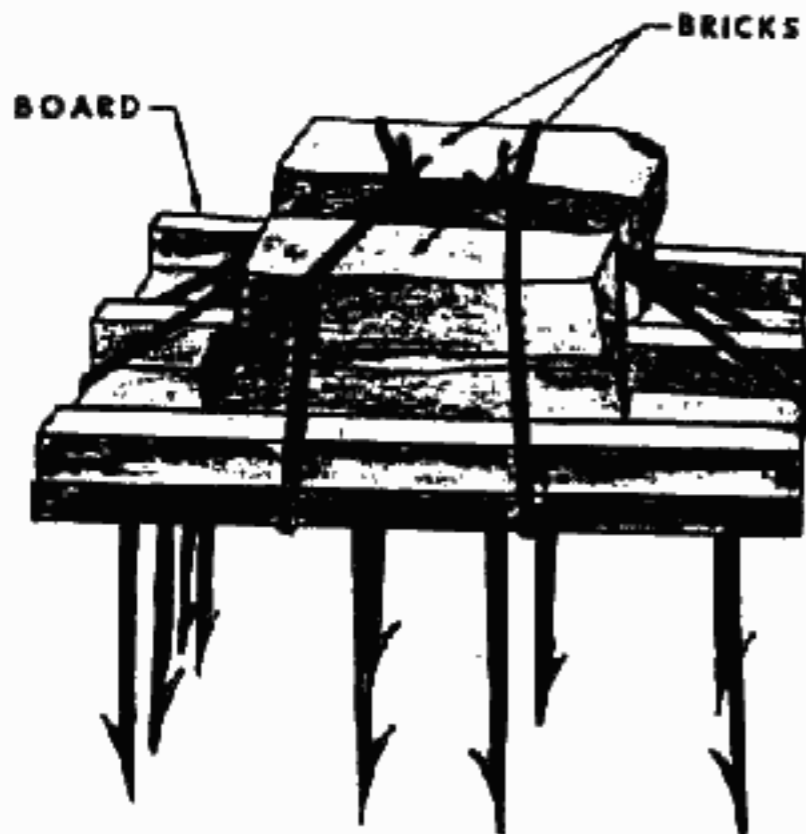

SUSPENDED SPIKES

91

Spike Log (Mace)

GENERAL DESCRIPTION AND COMMENT

The spike log is approximately 8 to 10 feet long and studded with spikes. It is often left in roadside ditches where it is hidden in the grass. In another emplacement, called the Mace, the spike log is suspended from a tree branch in such a way that, when a tripwire is pulled, the log swings down along the path or trail—impaling anyone in its way.



SPIKE LOG (MACE)

93

Cal. .22 Fountain Pen

GENERAL DESCRIPTION AND COMMENT

The caliber .22 fountain pen is actually a weapon which fires a .22-caliber rimfire cartridge. It is used by Viet Cong agents for assassinations. The illustration shows the pen in the uncocked position. When the device is cocked, the round stud (part of the firing pin) will be located in the notch at the left end of the slot in the cap. If the stud is pushed out of the notch, a compressed spring will drive the firing pin into the cartridge, causing it to fire. This device can be varied as a cigarette lighter.

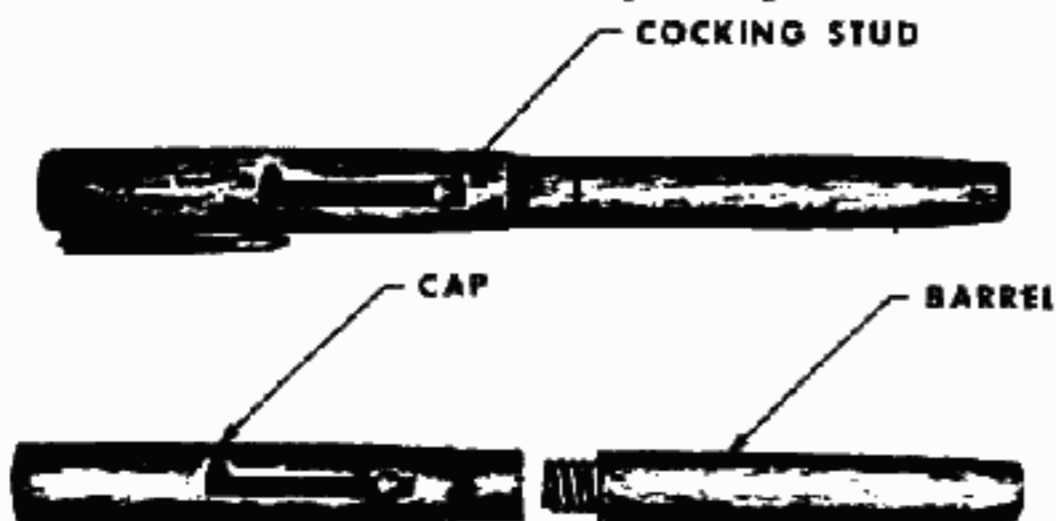

CAL. .22 FOUNTAIN PEN

95

Explosive Fountain Pen

GENERAL DESCRIPTION AND COMMENT

The explosive fountain pen is another type of boobytrap or harassing device. When the cap is unscrewed and removed from the barrel of the pen, two friction fuzes function and both cap and barrel explode in the hands of the person holding the pen.

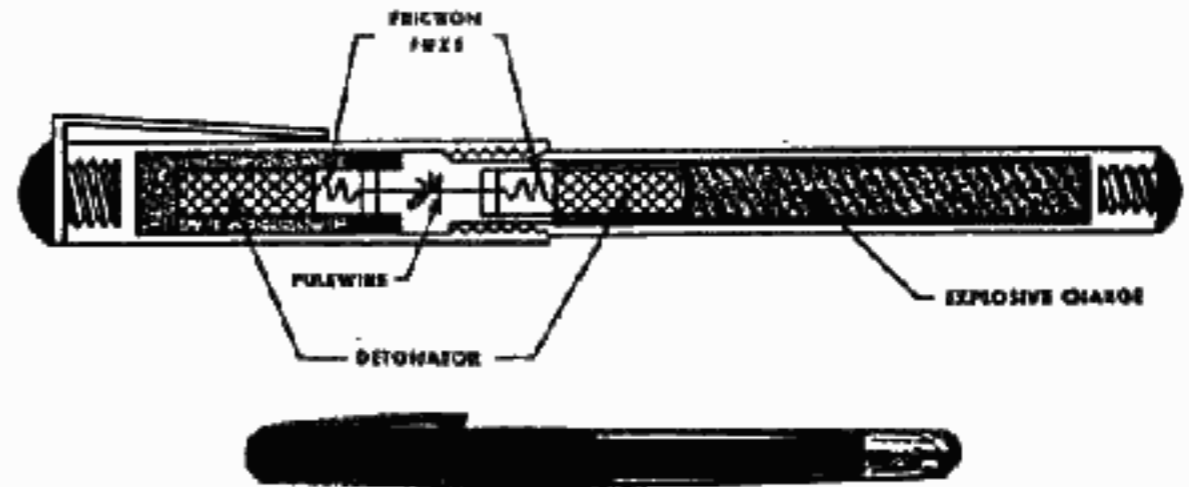

97

Sodium Incendiary Device

GENERAL DESCRIPTION AND COMMENT

The sodium incendiary device is constructed of two sheet metal hemispheres welded together and containing sodium suspended in a tar-like substance. The body has two holes in its outer surface. A wax and paper covering over the holes waterproofs the item when in storage. When the device is employed, the wax cover is removed, allowing water to contact the sodium and thereby creating heat and flame. This device is often employed in boat bilges and is particularly effective in any area with oil or gas seepage.

CHARACTERISTICS

Type	-----	Incendiary
Color	-----	Black
Diameter	-----	1.5 in
Weight	-----	1.5 oz
Filler	-----	Sodium

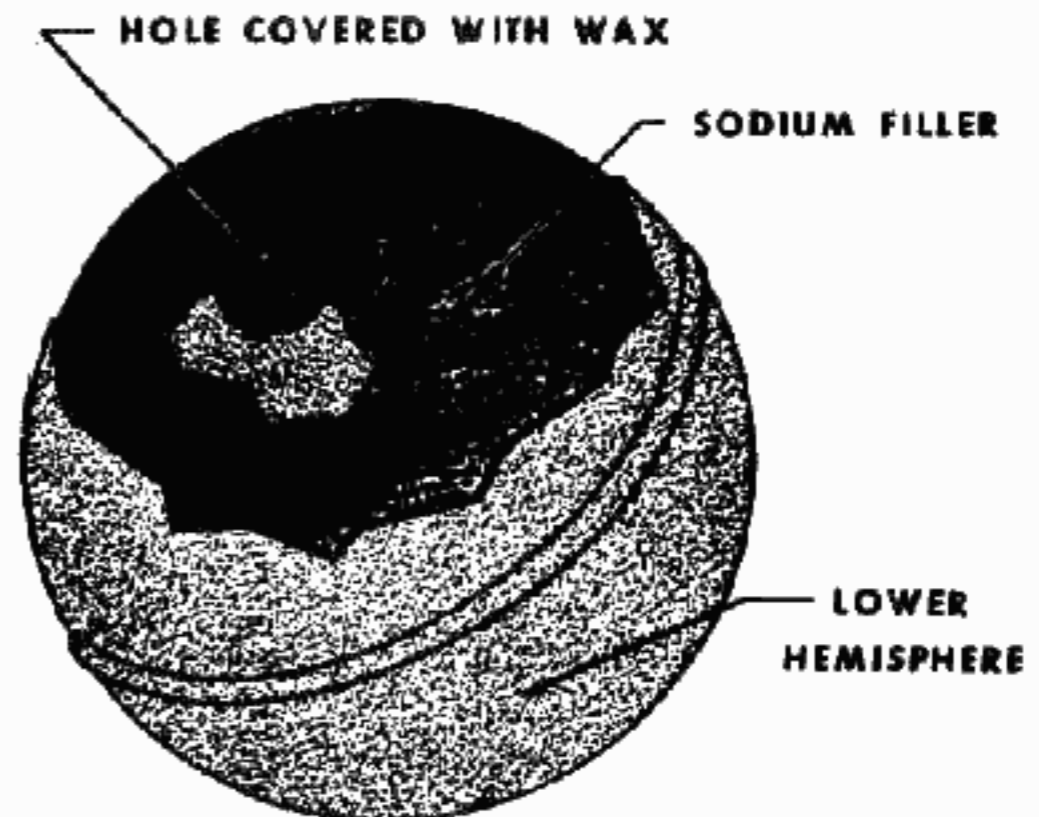

SODIUM INCENDIARY DEVICE

# GUIDE TO SELECTED VIET CONG EQUIPMENT AND EXPLOSIVE DEVICES

May 1966

Headquarters, Department of the Army  
Washington, D.C.

DEPARTMENT OF THE ARMY PAMPHLET

381-11

## FOREWORD

The purpose of this handbook is to provide United States military personnel with a compact source of orientation and recognition data on improvised equipment and explosive devices in use by the Viet Cong in the Republic of Vietnam.

The Viet Cong forces have acquired wide experience in constructing grenades, mines, fuzes, explosive charges, and other deadly weapons and devices by using commonly available materials. These devices, cunningly placed and camouflaged, have caused many casualties.

The authority for retention of war trophies by any individual is governed by directives of the senior U.S. Headquarters in the area concerned, as well as by pertinent regulations. Items of war materiel coming into the possession of U.S. forces will be reported through intelligence channels.

Evidence of errors or omissions in this handbook should be forwarded to the U.S. Army Foreign Science and Technology Center, Munitions Building, Washington, D.C., 20315.